

SVC

ENG **Smart Valve Controller**

Owner's manual and programming instructions

ESP **Programador Autónomo de Pila**

Instrucciones de instalacion y manual del usuario

FR **Programmateur Autonome**

Guide de l'utilisateur et Instructions d'installation

IT **Programmatore per Valvole Intelligente**

Guida per l'utente ed istruzioni per l'installazione

DE **Das Intelligente Magnetventil-Steuergerät**

Hinweise zur installation und bedienungsanleitung

PRT **Programador de Válvulas Inteligente**

Guia do utilizador e instruções de instalação

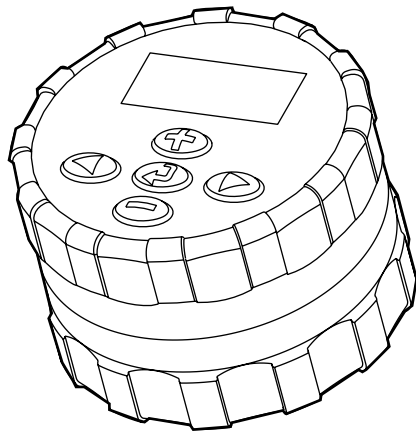

Hunter[®]

TABLE OF CONTENTS

- SVC Features..... 2
- SVC Components..... 2
 - LCD Display 2
 - Control Buttons 3
- Connecting the Battery 4
- Attaching Solenoids..... 5
- Mounting the SVC 6
 - To Mount the SVC to a Valve 6
 - Valve Box Mounting Method..... 6
 - Stake Mounting Method 7
- Connecting A Weather Sensor 7
- Programming 8
 - Setting the Date and Time 8
 - Setting Watering Start Times..... 8
 - Eliminating a Start Time..... 9
 - Setting the Run Time (Length of Watering) 9
 - Setting Days to Water 9
 - Selecting Specific Days of the Week to Water 9
 - Selecting Interval Watering 10

- Programming Stations to Operate Together (SVC-200 & SVC-400) 10
- System Off 10
- To Activate the Controller from the System Off Mode..... 11
- Programmable Rain Off..... 11
- Manual Watering 11
 - To Suspend Manual Watering to All Stations Operating 12
 - To Suspend Manual Watering to Individual Stations Operating 12
- Battery Life Indicator 12
- Troubleshooting Guide..... 13





SVC FEATURES

- Simple push button programming
- Operates up to four valves
- Large Liquid Crystal Display (LCD) with easy to understand icons
- Operates on a standard 9-volt alkaline battery
- Days-of-the-week water schedule
- Up to nine start times per day
- Run times from 1 minute to 4 hours
- Manual watering
- Low battery status shows status of life of battery
- Rain sensor (or other micro-switch sensor) compatible
- Multiple mounting options
- Non-volatile memory retains all program information

SVC COMPONENTS

This section provides a brief overview of some of the components of the SVC. Each item will be discussed in further detail later. However, this section can be helpful in getting acquainted with the different options available.

LCD Display

1. **Main Display** – Indicates all programmed information.
2. **Station Number** – Indicates the station number being programmed.
3.  **Current Time/Day** – Icon indicates when current day and clock are being set.
4.  **Run Times** – Icon indicates when Run Times are being set. Allows user to set run times from 1 minute to 4 hours.
5.  **Start Times** – Icon indicates when Start Times are being set.
6. **Start Time Number** – Indicates the start time number from 1 to 9.
7.  **Watering Days** – Allows the user to select individual days to water or a selected number of days between waterings (interval).

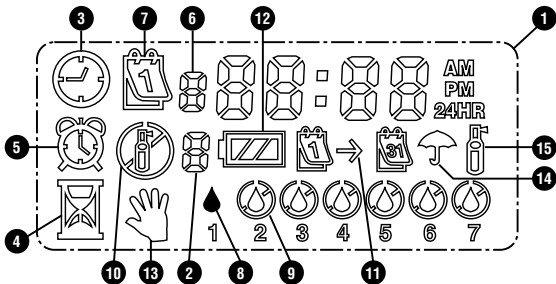

- 8. **Rain Drop** – Indicates that watering will occur on a selected day.
- 9. **Crossed Rain Drop** – Indicates that watering will **not** occur on a selected day.
- 10. **System Off** – Indicates that watering is suspended.
- 11. **Calendar** – Indicates interval watering schedule is being programmed. Allows the user to program 1 to 31 days between waterings.
- 12. **Battery Status** – Indicates the remaining life of the battery in the SVC.
- 13. **Manual On/Off** – Icon indicates when manual watering is programmed. Allows the user to activate the station manually.

- 14. **Sensor Interrupted** – Icon indicates that the rain sensor has shut down the system.
- 15. **Watering** – Icon indicates that watering is occurring.

Control Buttons

- Button** – Increases the selected flashing display.
- Button** – Decreases the selected flashing display.
- Button** – Selects programming function.
- Button** – Advances the selected flashing display to the next item.
- Button** – Navigates the selected flashing display back to the previous item.

CONNECTING THE BATTERY

The SVC uses a standard 9-volt alkaline battery (not included) to operate the valve and program the controller. Under normal conditions the battery should provide at least one full year of service. Use of a 9-volt lithium battery will extend the service life of the SVC between battery changes (approximately 3 years).



NOTE: The SVC has non-volatile memory which allows for the battery to be removed without losing any program information.

To Install the Battery

1. Unscrew the rear half of the SVC body to gain access to the battery compartment.
2. Snap the battery into the battery holder (use a high quality 9 volt alkaline battery).



NOTE: The battery holder is designed so that the battery can only be inserted one way.

3. Make sure no water is inside the battery compartment. Screw the SVC body halves together to seal the compartment.

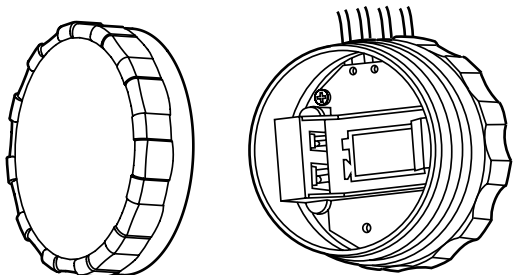

ATTACHING SOLENOIDS

The SVC-100 is provided with a solenoid attached to the controller. The SVC-200 and SVC-400 multi-station controllers will operate up to 2 or 4 solenoids, respectively. Hunter DC solenoids (P/N 458200) can easily be installed on all Hunter Plastic Valves. For the SVC-200 & SVC-400, solenoids must be ordered separately.



NOTE: Must use DC Latching Solenoids. 24VAC Solenoids will not operate with the SVC.

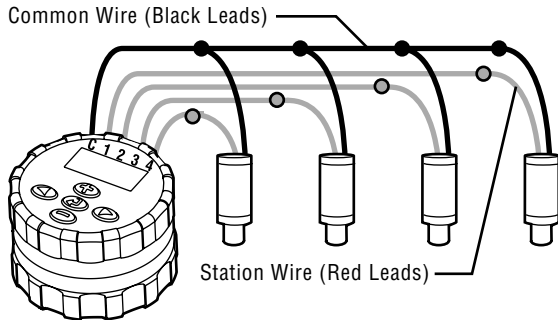

To Wire DC Solenoids to the SVC

1. Attach the black leads from each solenoid to the single common wire (black lead) coming from the SVC. Secure all wire connections with waterproof connectors.
2. Attach one red wire from each solenoid to the corresponding station wire (red lead) from the SVC. The station numbers are identified on the face of the SVC. Secure all wire connections with waterproof connectors.



NOTE: The maximum wire distance between the solenoid and SVC is 100 feet (18 gauge minimum wire size).

The SVC can also operate non-Hunter DC latching solenoids. Below is a list of SVC compatible solenoids.

Model	Solenoid
Baccara	G75-0-1002
Bermad	S392-2
Nelson	8090
Rain Bird	TBOSPSOL

MOUNTING THE SVC

The SVC can easily be mounted on any Hunter plastic valve. A specially designed valve mounting clip makes installation a snap. A protective rubber cover is provided to prevent dirt from accumulating on the face of the SVC.

To Mount the SVC to a Valve (Figure 1)

1. Unscrew the existing solenoid from the valve.
2. Screw the Hunter DC latching solenoid (P/N 458200) into the valve bonnet.
3. Attach the large end of the valve mounting clip to the middle of the SVC body.
4. Snap the small end of the valve mounting clip to the solenoid.

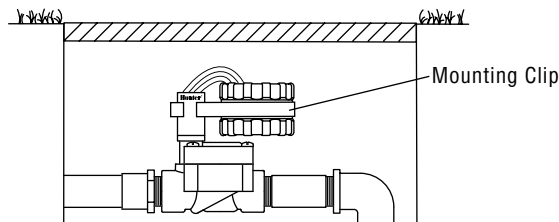

Figure 1

Along with the universal mounting clip, a mounting adapter is also provided with the SVC. This mounting adapter allows for alternate methods of mounting the controller either to the side of the valve box or stake mounted within the valve box.

Valve Box Mounting Method (Figure 2)

1. Position the universal mounting adapter on the side of the valve box. Make sure that the bracket is positioned so that the controller will not interfere with the valve box cover when closed.
2. Drive two screws to secure the adapter to the side of the valve box.
3. Attach the SVC to the mounting clip and slide it on the end of the mounting adapter.

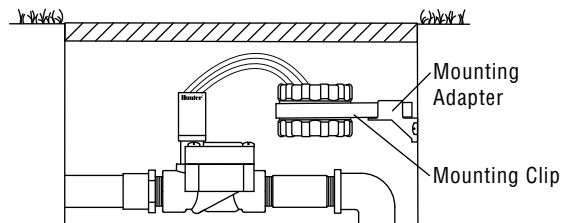

Figure 2

Stake Mounting Method (Figure 3)

The universal mounting adapter can also be used to stake mount the SVC.

1. Cut a section of ½" diameter plastic pipe.
2. Drive the pipe into the ground inside the valve box to the desired height of the controller.
3. Slip the mounting adapter on top of the pipe.
4. Attached the SVC to the mounting clip and slide onto the adapter.

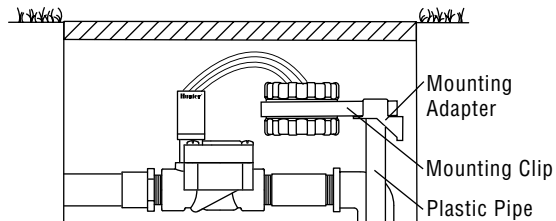

Figure 3

CONNECTING A WEATHER SENSOR

A Hunter Mini-Clik® rain sensor can be connected to the SVC. The purpose of this sensor is to stop watering when weather conditions dictate.



NOTE: When the Rain Sensor is interrupting the watering, the display will show the System Off icon (⊘), "OFF" and ☂ on the display.



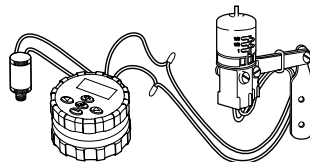



1. Cut the yellow wire loop attached to the SVC at approximately the middle of the loop.
2. Remove approximately ½" (13mm) of insulation from each wire. Attach one yellow wire to each of the wires of the weather sensor. You can mount the rain sensor up to 100 feet from the SVC controller (18 GA minimum wire size).
3. Secure wire connections with waterproof connectors.



Hunter Model Mini-Clik®



PROGRAMMING











The SVC utilizes independent station programming. For each station being programmed, you need to program at least one Start Time, a Run Time, and Water Day(s). The  button allows you to quickly navigate among programming options.

The SVC display shows time and day when the  button is pressed. The  button allows you to easily navigate among programming options. During a short period of inactivity, the display will shut off to retain battery power. When programming, the flashing portion of the display can be changed by pressing the  or  buttons. To change something that is not flashing, press the  or  buttons until the desired item is flashing.

The SVC allows for up to 9 start times per day. Multiple start times permit morning, afternoon, and evening watering, perfect for the establishment of new lawns and thirsty annual flowers. Simply designate the days of the week you want to water. The SVC makes it easy.





Setting the Date and Time

1. Press the  button until the Current Time/Day icon  is displayed.









2. Hours will be flashing. Press the  or  button to change the hour shown on the display. Press the  to proceed to setting the minutes.
3. Minutes will be flashing. Use the  or  button to change the minutes shown on the display. Press the  to proceed to select AM, PM, or 24 hour time.
4. The time will be displayed, and the time of day flashing. Press the  or  button to select AM, PM, or 24 hour. Press the  to proceed to setting the day of the week.
5. The number 1 will be flashing at the bottom of the display, indicating the first day of the week. Press the  or  buttons to select the day of the week (1 through 7) corresponding to the day.

The time and day have now been set.



Setting Watering Start Times

1. Push the  button until the Start Times icon  is displayed. A Start Time or "Off" will be flashing. The number directly to the left of the start time number (1 through 9) indicates the start time number. The number directly below the start time number indicates the station being programmed.
2. Use the  or  button to change the start time. (The start times advance in 5 minute increments.)

Hold either button down for 1 second to change times rapidly.

3. To add another start time to the station, press the  button. The start time icon and start time number will be flashing. Use the  or  buttons to change the start time number.
4. Press the  button. The start time will be flashing. Use the  or  buttons to change the start time.
5. To program start times for another station, press the  button. The station number will be flashing. Use the  or  buttons to select the next station (1 through 4). Repeat steps 3 and 4.



Eliminating a Start Time

With the display in the watering Start Time mode, push the  or  buttons until you reach 12:00 AM (midnight). From here push the  button once to reach the OFF position.





NOTE: If a station has all 9 start times turned off, then the station is off.

Setting the Run Time (Length of Watering)







1. Press the  button until the Run Time icon 

is displayed.



2. The display will show the last run time entered.
3. Use the  or  button to change the station run time on the display from 1 minute to 4 hours.
4. Press the  button to navigate to the next station number to be programmed.





Setting Days to Water

1. Push the  button until the Water Days icon  is displayed. The station number will also be displayed.
2. The controller will display seven days of the week with a  icon or a  icon above the numbered day. The  icon would represent an “On” water day, while the  icon would represent an “Off” watering day.
3. Use the  button to navigate to the next station to be programmed.

Selecting Specific Days of the Week to Water







1. With the  cursor on a specific day (the cursor always starts with day 1), press the  button to activate that day of the week to water. Press the  button to cancel watering for that day. After pressing a button the cursor automatically advances to the next day.
2. Repeat step 1 until all desired days have been selected.

PROGRAMMING (Continued)

The selected days will show with a  to indicate their status ON. The last  is the last watering day for the program.

→ Selecting Interval Watering

With this option you can select interval watering from 1 to 31 days.

1. With the  cursor on day 7, press the  button until the  →  interval watering icon and the two calendars appear on the display.
2. Press the  or  button to select the number of days between watering days (1 to 31). This is called the interval.

The controller will water the next Start Time and will then water at the interval programmed.

Programming Stations to Operate Together (SVC-200 & SVC-400)



The SVC-200 and SVC-400 allow for automatic watering of multiple valves at the same time. Up to four stations can operate at the same time. If more than one station has the

same start time, they will operate together (they must also be programmed with the same water day). For example, if Station 1 and 2 both have been programmed with start times of 8:00 am, they will both turn on and run at the same time.



The SVC allows for start time stacking which is helpful when system capacity is not adequate to support the operation of multiple valves at the same time. Let's assume a scenario in which Station 1 is programmed to start at 8:00 AM and run for 15 minutes, and Station 2 is programmed to start at 8:10 AM and run for 15 minutes. Station 1 watering run time overlaps Station 2 start time. The SVC will wait until Station 1 completes watering until it starts Station 2. In this scenario, Station 2 will start at 8:15 am.

System Off

This function permits the user to shut the system off for an indefinite period of time.





1. Press the mode button  until the  Crossed Sprinkler icon is displayed.
2. Wait 4 seconds and "Off" will appear on the display. The SVC is now in the System Off mode and will remain off until it is turned back on again.

To Activate the Controller from the System Off Mode

1. Press the mode button  once. The display will wake up in the System Off mode.
2. Press the mode button  again and “Off” will disappear from the display. The display will show the current time. Your controller is now on and will water automatically based upon the current program.

Programmable Rain Off







This feature permits the user to stop all programmed waterings for a designated period from 1 to 7 days. At the end of the programmable rain off period, the controller will resume normal automatic operation.

1. Press the  button until the  System Off icon is displayed. Wait 4 seconds and “Off” will appear on the display.
2. Press the  button and a 1 will be displayed. The 1 will be blinking at this point.
3. Press the  button as many times as needed to set the number of days off desired (up to 7). The SVC will wait the number of days selected and then reactivate automatic watering.

Manual Watering

The SVC features a simple one touch manual start. One or more stations can be programmed to run manually at the same time.

To Activate a Manual Watering:



1. Press the  button once to display the current time of day.
2. Press and hold the  button for two seconds to display the  Manual Watering icon. The station number will also be displayed.
3. Use the  or  button to adjust the manual water run time from 1 minute to 4 hours.
4. Release the buttons and the controller will count down 10 seconds before activating the manual cycle.
5. The  flashing sprinkler icon will appear on the display when watering is occurring.
6. To activate another station, use the  button to select the station you would like to manually water, repeat steps 3 and 4.

Note: While manual watering is occurring the display will briefly display the station number and the time watering remaining for each station that is operating. The manual



PROGRAMMING (Continued)

water run time can be increased or decreased for any time that the station is displayed.



To Suspend Manual Watering to All Stations Operating

1. Press the  button until the  System Off icon is displayed. Wait 4 seconds and "OFF" will appear on the display. All stations will turn off.
2. Press the  button again and the current time and day will be displayed. The SVC will now water based upon the current program.

To Suspend Manual Watering to Individual Stations Operating

1. Press the  button and the display will show each of the stations operating manually.
2. When the station number appears for the station that you would like to suspend manual watering, press the  button once. The time remaining displayed will change to "Off" and the station will turn off.
3. Repeat steps 1 and 2 to suspend watering for additional stations.

BATTERY LIFE INDICATOR

The battery life status icon  is a quick way to determine the remaining life of the installed battery without having to remove the battery from the controller. A battery life status icon will appear along with the time and day on the display. A fully charged battery will show all three segment of the battery dark . As the battery is expended, the segments will appear as outlines .

TROUBLESHOOTING GUIDE

PROBLEM	CAUSES	SOLUTIONS
There is no display.	Display is off. Battery is dead.	Press any button for 1 second. Replace the battery.
Display indicates watering but none is occurring.	No water pressure. Faulty solenoid. Incompatible solenoid.	Turn on main system supply. Replace solenoid. Must use Hunter DC Latching Solenoid (P/N 458200) or other compatible DC latching solenoid.
Automatic irrigation does not start at start time.	Controller in System Off mode. AM/PM of time of day not set correctly. AM/PM of start time not set correctly.	Verify that controller is programmed for automatic watering. Correct AM/PM of time of day. Correct AM/PM of start time.
Rain sensor does not suspend watering.	Rain sensor defective or miswired.	Verify proper operation of the rain sensor and wire connections (see page 10).
Controller waters more than one time.	Too many start times have been entered (up to 9 start times per day).	Each station start time activates a station run time. Set only one start time for once per day watering.

CONTENIDO

Características del SVC	16	Programación de estaciones para sufuncionamiento conjunto (SVC-200 y SVC-400)	24
Componentes del SVC	16	Sistema Apagado (OFF).....	24
Pantalla LCD.....	16	Para activar el programador desde una posición de “OFF” (apagado).....	25
Botones de control	17	Programación Por Días de Lluvia (OFF)	25
Instalación de la Pila.....	18	Para activar el Riego Manual	25
Conexión de Solenoides	19	Para suspender el riego manual para todas las estaciones en funcionamiento	26
Montar el SVC	20	Para suspender el riego manual de todas las estaciones en funcionamiento	26
Para instalar el programador SVC a una electroválvula.....	20	Indicador de Duración de la Pila.....	26
Método de Instalación Arqueta	20	Guía para Solucionar Problemas	27
Método de Instalación de Estaca	21		
Programación.....	22		
Programación del Día y la Hora	22		
Arranque del Ciclo	22		
Eliminar un Arranque de Ciclo	23		
Regulación de Tiempos de Riego (Tiempo de Riego de Cada Área)	23		
Regulación de Días de Riego	23		
Selección de Días Semanales Específicos de Riego	23		
Selección de Riego a Intervalo	24		





CARACTERÍSTICAS DEL SVC

- Sencilla programación con un botón pulsador
- Pone en funcionamiento hasta cuatro electroválvulas
- Gran pantalla de cristal líquido (LCD) con símbolos fáciles de entender
- Funciona con una pila alcalina de 9 voltios estándar
- Programa de riego de “días de la semana”
- Hasta nueve tiempos de inicio al día (arranques diarios)
- Tiempos de riego desde 1 minuto hasta 4 horas
- Riego manual
- El estado de pila bajo muestra la duración de la pila
- Sensor de lluvia (u otro sensor microinterruptor) compatible
- Múltiples opciones de montaje
- La memoria no volátil retiene toda la información del programa

COMPONENTES DEL SVC

Esta sección ofrece una breve descripción de algunos de los componentes del SVC. Más adelante se hablará de cada artículo más detalladamente, sin embargo, esta sección puede servir de ayuda para una primera toma de contacto con las diferentes opciones disponibles.

Pantalla LCD

1. **Pantalla principal** – Indica toda la información sobre la programación.
2. **Número de estación** – Indica el número de la estación que está siendo programada.
3.  **Día / hora actual** – El símbolo indica cuando están establecidos el día y el reloj actuales.
4.  **Tiempos de riego** – El símbolo indica cuando se establecen los tiempos de riego.
5.  **Horas de arranque** – El símbolo indica cuando se establecen los tiempos de inicio.
6. **Número de tiempo de inicio** – Indica el número de tiempo de inicio desde 1 hasta 9.
7.  **Días de riego** – Permite seleccionar días de riego individuales o un número de días entre riegos (intervalo).
8.  **Gota de agua** – Indica que el riego tendrá lugar en el día seleccionado.

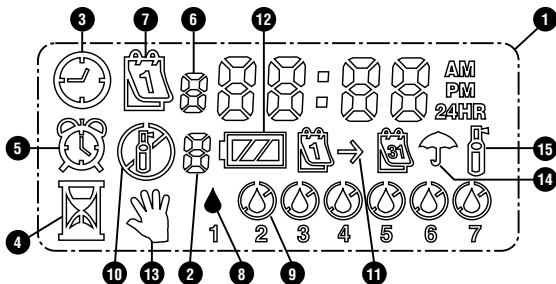

9. **Gota de agua tachada** – Indica que el riego no tendrá lugar en el día seleccionado.
10. **Parado** – Indica que se ha suspendido el riego.
11. **Calendario** – Indica que el programa de riego de intervalo se está programando. Permite al usuario programar el día de riegos en intervalos entre 1 a 31 días.
12. **Estado de la batería** – Indica la duración restante de la pila en el SVC.
13. **Marcha manual** – El símbolo indica cuando está programado el riego manual. Permite activar la estación manualmente.
14. **Sensor interrumpido** – El símbolo indica que el sensor de lluvia ha cerrado el sistema.

15. **Regando** – El símbolo indica que está teniendo lugar el riego.

Botones de control

- Botón** – Aumenta la pantalla intermitente seleccionada.
- Botón** – Disminuye la pantalla intermitente seleccionada.
- Botón** – Selecciona la función de programación.
- Botón** – Avanza la pantalla intermitente seleccionada hasta el siguiente artículo.
- Botón** – Retrocede la pantalla intermitente seleccionada hasta el artículo anterior.

INSTALACIÓN DE LA PILA

El SVC usa una pila alcalina estándar de 9 voltios (no se incluye) para operar la electroválvula y el programador. La duración de la pila se determina en proporción al número de veces en que se use la electroválvula. Sin embargo, bajo condiciones normales, la pila deberá proporcionar cuando menos un año de servicio.



NOTA: El SVC cuenta con una memoria no volátil la cual permite cambiar la pila sin que se pierda ninguna información del programa.

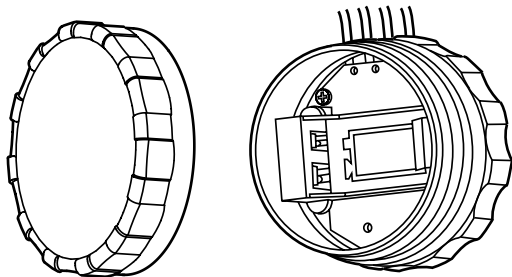

Para instalar la pila

1. Desenrosque la parte posterior del cuerpo del SVC para tener acceso al compartimiento de la pila.
2. Inserte la pila en el compartimiento respectivo.



NOTA: El compartimiento de la pila está diseñado para que la misma solamente pueda insertarse en una sola dirección.

3. Asegúrese que no existan residuos de agua dentro del compartimiento de la pila. Enrosque las dos partes del cuerpo del SVC para sellar el compartimiento.

CONEXIÓN DE SOLENOIDES

Con el SVC-100 se incluye un solenoide conectado al programador. Los SVC-200 y SVC-400 son capaz de poner en funcionamiento hasta dos o cuatro solenoides latch de CD individuales. Los solenoides de CD Hunter (P/N 458200) son fáciles de instalar en todas las electroválvulas de plástico de Hunter. Los solenoides deben pedirse por separado para los programadores SVC-200 y SVC-400.



NOTA: Se deben usar solenoides latch de CD. Los solenoides de 24VCA no funcionarán con el SVC.

Cable común (cable de color negro)

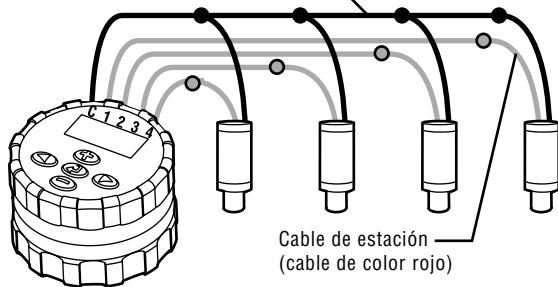

Para conectar los solenoides de CD al SVC

1. Conecte los cables negros desde cada solenoide hasta el cable común único (cable negro del programador SVC) . Asegure todas las conexiones de cables con conectores impermeables.
2. Conecte el cable rojo desde cada solenoide al cable de la estación correspondiente (cable rojo del programador SVC). Los números de estación están identificados en la cara del SVC. Asegure todas las conexiones de cables con conectores impermeables.



NOTA: La máxima distancia de cable entre el solenoide y el SVC es de 30 metros (para cable de una sección mínima de 1mm (18)).

El SVC puede funcionar también solenoides latch de CD que no sean de Hunter. Más adelante hay una lista de solenoides compatibles con el SVC.

Modelo	Solenoide
Baccara	G75-0-1002
Bermad	S392-2
Nelson	8090
Rain Bird	TBOSPSOL

MONTAR EL SVC

El programador SVC puede instalarse fácilmente a cualquier electroválvula de plástico Hunter. Se proporciona un sello protector para evitar la acumulación de la suciedad en la carátula del programador SVC.

Para instalar el programador SVC a una electroválvula (Figura 1)

1. Desenrosque el solenoide existente de la electroválvula.
2. Enrosque el solenoide de la SVC o latch en la tapa de la electroválvula.
3. Inserte el SVC en el clip de sujeción.
4. Sujete el clip en el solenoide de la electroválvula.



Figura 1

También se proporcionan para la instalación de su programador SVC, una grapa universal y adaptadora de instalación. Lo anterior, proporcionan varios sistemas de montaje del programador ya sea al lado de la arqueta, o bien, para ser instalado dentro de la misma.

Método de Instalación Arqueta (Figura 2)

1. Posicione el adaptador de instalación universal al lado de la arqueta. Asegúrese de que el clip de sujeción esté instalado de forma tal que el programador no interfiera con la tapa de la arqueta.
2. Inserte dos tornillos para asegurar el adaptador al lado de la arqueta.
3. Sujete el programador SVC al clip de instalación y deslícelo a la sección final del adaptador de instalación.

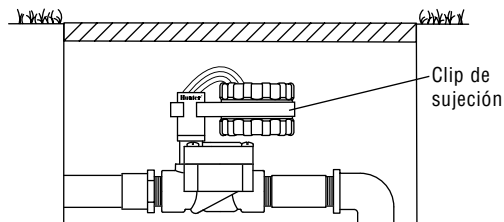

Figura 2

Método de Instalación de Estaca (Figura 3)

El adaptador de instalación universal puede también utilizarse para una instalación de su SVC tipo Estaca.

1. Corte una sección de tubo de plástico de ½" de diámetro.
2. Inserte el tubo en el suelo dentro de la caja de la electroválvula a la altura deseada con respecto al programador.
3. Coloque el adaptador de instalación en la parte superior del tubo.
4. Instale el programador SVC al clip de instalación y deslícelo sobre el adaptador.

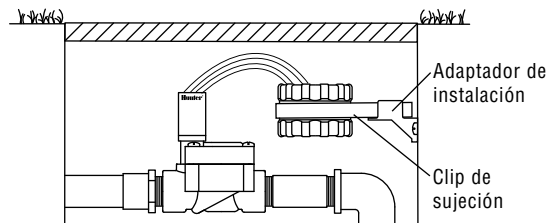



Figura 3

INSTALACIÓN A UN SENSOR DE CLIMA

El programador SVC se puede conectar a un sensor tipo Hunter Mini-Clik®, o bien, a otros tipos de sensores de clima. El propósito de dicho sensor es de interrumpir el riego cuando las condiciones del clima así lo exijan.

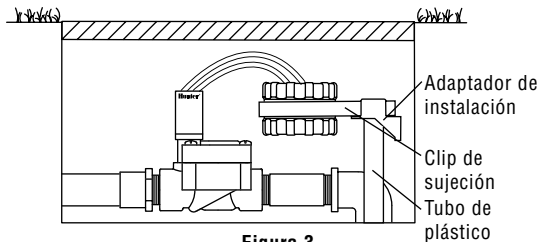

NOTA: Cuando el sensor interrumpe el flujo de riego, aparecerá en la pantalla el icono  de Sistema Desconectado, "OFF" y el icono .



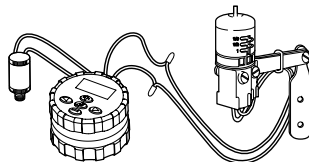



1. Corte el círculo del cable amarillo pegado al SVC aproximadamente en medio del círculo.
2. Pele aproximadamente 13 mm del cable aislante de cada cable. Conecte posteriormente, cada cable a cada uno de los cables del sensor de clima. Se puede montar el sensor de lluvia en una distancia de hasta 30,5 metros del programador SVC-400 (con una sección mínima de cable de 1 mm²).
3. Asegure las conexiones del cable con conectores impermeables.



Modelo Mini-Clik® de Hunter













PROGRAMACION

El SVC utiliza programación de estación independiente. Para cada estación que se está programando, es necesario programar al menos un Tiempo de Inicio, un Tiempo de Riego y Día(s) de Riego. El botón  le permite navegar rápidamente por las opciones de programación.

La pantalla SVC muestra el día y la hora cuando se presiona la tecla  correspondiente. Las teclas  le permiten navegar entre las opciones del programa. Durante un periodo de tiempo relativamente corto de inactividad, la pantalla se apagará para conservar energía de la pila. Al programar, la función intermitente de la pantalla podrá ser cambiada al presionar las teclas  ó . Para modificar algo que no esté intermitente en la pantalla presione las teclas  o  bien, hasta seleccionar que la función deseada esté intermitente.



El programador SVC permite hasta 9 diferentes tiempos de arranque. Los múltiples tiempos de arranque permiten ejecutar riegos en la mañana, en la tarde, o bien, en la noche, lo cual proporciona una funcionabilidad perfecta para céspedes recién plantados y para algunas clases de flora que consumen mucha agua en forma anual. Simplemente designe los días de la semana que desea regar. El SVC facilita dichas funciones.

Programación del Día y la Hora

1. Seleccione la tecla  hasta que aparezca en la pantalla  el icono de la Hora y Día Actual.
2. La hora será intermitente. Presione las teclas  ó  para cambiar la hora. Presione  para proceder a programar los minutos.
3. Los minutos serán intermitentes. Use  ó  para modificarlos. Presione  y proceda a seleccionar AM, PM ó 24 horas.
4. La hora aparecerá en la pantalla, y la hora del día será intermitente. Presione las teclas  ó  para seleccionar AM, PM, ó 24 horas. Presione la tecla  para proceder a programar los días de la semana.
5. El número 1 será intermitente, indicando el primer día de la semana. Presione las teclas  ó  para seleccionar el día de la semana (1 a 7) correspondiente.

La hora y el día han sido correctamente programados.

Arranque del Ciclo

1. Presione la tecla  hasta que aparezca en la pantalla  el icono de Start Times. Se pondrá intermitente un Tiempo de Inicio o bien "Off". El número que hay justo a la izquierda del tiempo de inicio (de 1 a 9) indica el número del tiempo de inicio. El número directamente debajo del número de tiempo de inicio indica la estación que se está programando.

- Utilice las teclas ó para cambiar el tiempo de arranque. Este avanzará en incrementos de 5 minutos. Presione la tecla por 1 segundo para avanzar rápidamente.
- Para añadir otro tiempo de inicio a la estación, pulse el botón . El símbolo de tiempo de inicio y el número de tiempo de inicio se pondrán intermitentes. Use los botones ó para cambiar el número del tiempo de inicio.
- Pulse el botón . El tiempo de inicio se pondrá intermitente. Use los botones ó para cambiar el tiempo de inicio.
- Para programar los tiempos de inicio para otra estación, pulse el botón . El número de estación se pondrá intermitente. Use los botones ó para seleccionar la siguiente estación (entre 1 y 4). Repita los pasos 3 y 4.

Eliminar un Arranque de Ciclo

Con la pantalla en la posición de Arranque de Ciclo, presione las teclas ó hasta llegar a las 12:00 AM (medianoche). Ahí presione la tecla una sola vez hasta alcanzar la posición de "OFF".



NOTA: Si su SVC tiene todas las 9 opciones de arranque apagadas (en posición "OFF") entonces estará apagado sin ningún arranque.

Regulación de Tiempos de Riego (Tiempo de Riego de Cada Área)

- Presione la tecla hasta que el icono Regulación de Tiempo de Riego aparezca en la pantalla .
- La pantalla demostrará la última opción programada.
- Utilice las teclas ó para modificar el arranque que desea, el cual podrá ser entre 1 minuto hasta 4 horas.
- Pulse el botón para navegar hasta el siguiente número de estación que se va a programar.



Regulación de Días de Riego



- Presione la tecla hasta que el icono Regulación de Días de Riego aparezca en la pantalla. También se mostrará el número de estación.
- El programador mostrará en la pantalla los siete días de la semana con icono ó bien, arriba del día numerado. El icono representará que un día está "ON" (en marcha), mientras que el icono representa un día en que está "OFF" (apagado).
- Pulse el botón para navegar hasta el siguiente número de estación que se va a programar.

Selección de Días Semanales Específicos de Riego

- Con el icono sobre un día específico (siempre comienza en 1), presione la tecla para activar un día en particular







PROGRAMACION (Continua)

de riego en la semana. Presione la tecla  para cancelar el riego del día seleccionado. Después de presionar cualquier tecla el cursor avanzará al siguiente día.

2. Repita el paso anterior hasta seleccionar los días deseados de riego. Los días seleccionados para regar serán indicados con el icono , lo cual indica que dicho día está "ON" (prendido). El último icono  es el último día de riego del programa.

→ Selección de Riego a Intervalo

Con esta opción podrá seleccionar intervalos de riego de 1 a 31 días.

1. Con el cursor  en el día 7, presione la tecla  hasta que los dos calendarios a intervalos  →  estén intermitentes en la pantalla.
2. Presione las teclas  ó  para seleccionar el número de días a intervalo (1 al 31). Esto se llama el intervalo.

El programador regará durante el siguiente arranque de ciclo como ha sido programado.

Programación de estaciones para su funcionamiento conjunto (SVC-200 y SVC-400)



El SVC-200 y SVC-400 permiten el riego automático de múltiples electroválvulas a la vez. Si más de una estación tienen el

mismo tiempo de inicio, éstas se pondrán en funcionamiento a la vez, funcionarán juntas (además éstas deben ser programadas con el mismo día de riego). Por ejemplo, si tanto la Estación 1 como la 2 han sido programadas con un tiempo de inicio de las 8:00 AM, ambas se pondrán en marcha y funcionarán a la vez.



El SVC tiene en cuenta la acumulación de tiempos de inicio, lo cual ayuda cuando la capacidad del sistema no puede soportar la operación de múltiples electroválvulas a la vez. Supongamos que la Estación 1 se ha programado para que comience a las 8:00 AM y que funcione durante 15 minutos, y la Estación 2 se programa para que empiece a las 8:10 AM y que funcione durante 15 minutos. El tiempo de ejecución de riego de la Estación 1 solapa el tiempo de inicio de la Estación 2. El SVC esperará a que la Estación 1 complete su riego para iniciar la Estación 2. En este caso, la Estación 2 se iniciará a las 8:15 AM.

Sistema Apagado (OFF)

Esta función permite al usuario apagar el sistema por un periodo de tiempo indefinido.





1. Presione la tecla  hasta que el icono  aparezca en la pantalla.
2. Espere durante 4 segundos y la leyenda "OFF" aparecerá en la pantalla. El programador SVC esta ahora en módulo de "OFF" (apagado) y permanecerá en dicha condición hasta que se encienda nuevamente.

Para activar el programador desde una posición de “OFF” (apagado)

1. Presione la tecla  del módulo una vez. La pantalla se prenderá despertando al sistema de su módulo “OFF” apagado.
2. Presione el modulo nuevamente y “OFF” desaparecerá de la pantalla . La pantalla mostrará la hora actual. Su programador está en posición de marcha y entrará en funciones de riego automático basado en el programa actual.

Programación Por Días de Lluvia (OFF)







Esta función le permite al usuario interrumpir todos los ciclos de riego por periodo designado entre 1 a 7 días. Al fin de dicho periodo programado por días de lluvia, el programador regresará a su función operativa normal en forma automática.

1. Presione la tecla  hasta que el icono  aparezca en la pantalla. Espere 4 segundos y aparecerá en pantalla “OFF” (apagado).
2. Presione la tecla  y el número 1 aparecerá en la pantalla. Dicho número estará intermitente en este momento.
3. Presione la tecla  tantas veces como sean necesarias para programar los días de la semana en que se opte por interrumpir las funciones de riego (hasta un máximo de 7). El SVC esperará el número de días seleccionados y luego volverá a activar el riego automático.

Marcha Manual

El SVC ofrece un fácil inicio manual rápido. Se pueden programar una o más estaciones para que funcionen al mismo tiempo en modo manual.



Para activar el Riego Manual

1. Presione la tecla  una vez para que aparezca la hora y el día actual en la pantalla.
2. Presione y sostenga el icono  por dos segundos para que aparezca el icono , indicando Riego Manual. También mostrará la hora actual.
3. Utilice las teclas  ó  para ajustar los ciclos de riego deseados desde 1 minuto hasta 4 horas.
4. Deje de presionar las teclas y el programador contará hasta 10 segundos antes de activar el ciclo de riego manual.
5. El icono de aspersión  intermitente aparecerá en la pantalla cuando el ciclo de riego ocurra.
6. Para activar otra estación, use el botón  para seleccionar la estación con la que desea regar manualmente, repita los pasos 3 y 4.



Nota: mientras está teniendo lugar el riego, la pantalla mostrará brevemente el número de estación y el tiempo de riego restante para cada estación que está en funcionamiento. Se puede aumentar o disminuir el tiempo de ejecución de riego manual a cualquier tiempo que se muestra en la estación.

PROGRAMACION (Continua)

Para suspender el riego manual para todas las estaciones en funcionamiento



1. Pulse el botón  hasta que se muestre el símbolo de Sistema Apagado . Espere 4 segundos y aparecerá en la pantalla "OFF" (apagado). Se apagarán todas las estaciones.
2. Pulse el botón  de nuevo y se mostrarán la hora y el día actuales. El SVC regará ahora basándose en el programa actual.

Para suspender el riego manual de todas las estaciones en funcionamiento

1. Pulse el botón  y la pantalla mostrará cada una de las estaciones que están funcionando manualmente.
2. Cuando aparezca el número de estación en la que desea suspender el riego manual, pulse el botón  una vez. El tiempo restante que se muestra cambiará a "OFF" (apagado) y la estación se apagará.
3. Repita los pasos 1 y 2 para suspender el riego para estaciones adicionales.

INDICADOR DE DURACIÓN DE LA PILA

El icono  representativo de la duración de la pila es una forma rápida de determinar la duración remanente de la pila instalada sin que se tenga que remover la misma del programador. Un indicador de la duración de la pila aparecerá junto con la hora y el día que aparezcan en la pantalla.

Una pila  totalmente cargada mostrará sus tres segmentos indicativos oscuros. Conforme la pila se descarga, sus segmentos aparecerán con líneas diagonales .

GUIA PARA SOLUCIONAR PROBLEMAS

PROBLEMA	CAUSAS	SOLUCIONES
El emisor está en blanco.	El Transmisor está apagado. La pila está descargada.	Presione cualquier tecla por 1 segundo. Cambie la pila.
La pantalla indica que el programa de riego está encendido pero no sale agua.	La salida del agua no tiene presión alguna. Tiene fallas el solenoide. Solenoide incompatible.	Encienda el interruptor principal del sistema. Cambie el solenoide. Fije sólo un tiempo de inicio para un solo riego al día.
El sistema automático de riego no arranca cuando se enciende el sistema.	El programador del sistema está apagado (OFF). La opción AM/PM no está correctamente programada. La opción AM/PM de arranque del sistema no está correctamente programada.	Verifique que el programador esté encendido. Programa correctamente la opción AM/PM. Programa correctamente la opción de arranque AM/PM.
El sensor no interrumpe la sesión de riego.	El sensor está defectuoso o los cables están mal instalados.	Verifique que el correcto funcionamiento del sensor y la instalación de los cables.
El programador inicia sesión de riego más de una vez.	Se han programado demasiadas sesiones de inicio de arranque (hasta 9 tiempos de inicio al día).	Una sesión de arranque activa un arranque completo (vea Programando los Ciclos de Arranque). Fije sólo un tiempo de inicio para un solo riego al día.

TABLE DES MATIERES

Fonctionnalités du SVC	30	Désactivation du système	39
Composants du SVC	30	Réactivation du système lorsqu'il est désactivé.....	39
Écran LCD	30	Interruption d'arrosage programmable	39
Boutons de commande	31	Arrosage en mode manuel.....	39
Mise en place de la pile.....	32	Pour suspendre l'arrosage manuel sur toutes les stations en fonctionnement.....	40
Raccordement des solénoïdes.....	33	Pour suspendre l'arrosage manuel sur des stations individuelles en fonctionnement	40
Montage du SVC.....	34	Indicateur de durée de vie de la pile	41
Montage du SVC sur une vanne.....	34	Guide de dépannage	42
Montage sur un côté du regard	34		
Montage sur piquet.....	35		
Raccordement d'une sonde.....	35		
Programmation	36		
Réglage de la date et de l'heure.....	36		
Réglage des départs de cycle d'arrosage	36		
Suppression d'un départ de cycle d'arrosage	37		
Réglage de la durée d'arrosage	37		
Réglage des jours d'arrosage	37		
Sélection d'un intervalle entre deux arrosages	38		
Programmation des stations pour un fonctionnement simultané	38		





FONCTIONNALITES DU SVC

- Programmation simple avec boutons poussoirs
- Commande jusqu'à 4 vannes
- Grand écran à cristaux liquides (LCD) avec des icônes faciles à comprendre
- Fonctionne avec une pile alcaline 9 volts standard
- Programmation d'arrosage par jours de semaine
- Jusqu'à 9 heures de départ différents par jour
- Temps de fonctionnement de 1 minute à 4 heures
- Arrosage manuel
- Un indicateur affiche la durée de vie de la pile
- Sonde compatible de pluie (ou autre sonde micro-switch)
- Multiples options de montage
- La mémoire non-volatile garde toutes les données du programme

COMPOSANTS DU SVC

Cette section fournit un bref aperçu de certains des composants des programmeurs SVC. Chaque élément sera présenté plus en détail ultérieurement, cependant, cette section peut être utile pour se familiariser avec les différentes options disponibles.

Écran LCD

1. **Écran principal** – Indique toutes les informations programmées.
2. **Numéro de station** – Indique le numéro de la station en cours de programmation.
3.  **Jour et heure** – Icône qui indique que la date et l'heure sont en cours de réglage.
4.  **Temps d'arrosage** – Icône qui indique que les temps de fonctionnement sont en cours de réglage.
5.  **Départs cycle** – Icône qui indique que les heures de départ sont en cours de réglage.
6. **Nombre de départs de cycle** – Indique le nombre d'heures de départ de 1 à 9.
7.  **Jours d'arrosage** – Permet à l'utilisateur de choisir des jours d'arrosage individuels ou un nombre de jours déterminé entre chaque arrosage (intervalle).

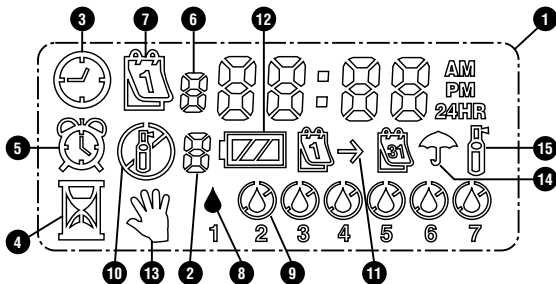

8. **▲ Goutte de pluie** – Indique que l'arrosage se produira un jour déterminé.
9. **☂ Goutte de pluie barrée** – Indique qu'il n'y aura pas d'arrosage un jour déterminé.
10. **⏸ Arrêt** – Indique que l'arrosage est suspendu.
11. **📅 → 📅 Calendrier** – Indique que la prévision des jours d'arrosage est en cours de programmation. Permet à l'utilisateur de programmer des intervalles allant de 1 à 31 jours entre les arrosages.
12. **🔋 État de la pile** – Indique la durée de vie restante de la pile du SVC.
13. **👤 Marche manuelle** – Icône qui indique que l'arrosage manuel est programmé. Permet à l'utilisateur d'activer la station manuellement.

14. **☂ Interruption capteur** – Icône qui indique que le capteur de pluie a arrêté le système.

15. **🚰 Arrosage en cours** – Icône qui indique que l'arrosage est en cours.

Boutons de commande

- ➡ **Bouton** – Augmente la valeur de l'élément affiché clignotant.
- ⬅ **Bouton** – Diminue la valeur de l'élément affiché clignotant.
- 👉 **Bouton** – Sélectionne la fonction de programmation.
- ▶ **Bouton** – Fait clignoter l'élément affiché suivant.
- ◀ **Bouton** – Fait clignoter l'élément affiché précédent.

MISE EN PLACE DE LA PILE

Le SVC est alimenté par une pile alcaline de 9 volts (non fournie) qui est nécessaire pour le programmer et pour actionner la vanne. La durée de vie de la pile est déterminée par le nombre d'actionnements de la vanne, cependant, dans des conditions normales de fonctionnement, elle devrait offrir une autonomie d'au moins une année d'utilisation.



NOTE: Le SVC contient une mémoire non volatile qui vous permet de changer la pile sans perdre les informations de programmation.

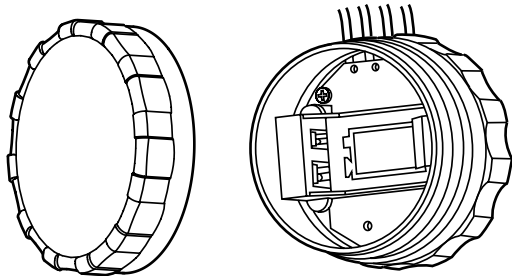

Mise en place de la pile

1. Dévissez la partie arrière du boîtier du SVC pour accéder au logement de la pile.
2. Mettez la pile en place dans son logement.



NOTE: Le logement est conçu pour ne permettre l'insertion de la pile que d'une seule manière.

3. Assurez-vous qu'il n'y a pas d'eau à l'intérieur du logement de la pile. Vissez les deux moitiés du SVC pour que le tout soit étanche.

RACCORDEMENT DES SOLENOÏDES

Le SVC-100 est fourni avec un solénoïde attaché au programmateur. Le SVC-200 et SVC-400 est capable de piloter jusqu'à deux ou quatre solénoïdes. Les solénoïdes de Hunter (ref. 458200) peuvent être installés facilement sur toutes les vannes en plastique de Hunter. Ils doivent être commandés séparément pour les SVC-200 et SVC-400.



NOTE : Il faut utiliser les solénoïdes à impulsion. Les solénoïdes 24 volts ne fonctionneront pas avec le SVC.

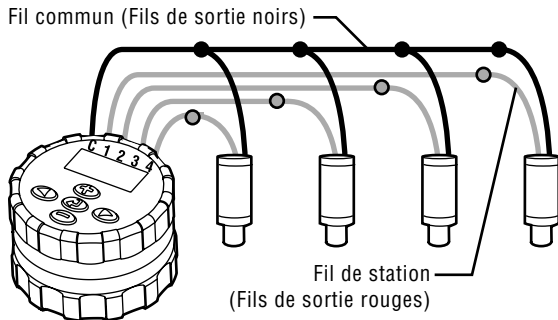

Pour câbler les solénoïdes au SVC

1. Raccordez les fils noirs de chaque solénoïde au fil commun unique (fil noir) provenant du SVC. Assurez toutes les connexions avec des connecteurs étanches.
2. Raccordez un fil rouge de chaque solénoïde au fil de la station correspondant (fil rouge) du SVC. Les numéros de stations sont identifiés sur la face du SVC. Assurez toutes les connexions avec des connecteurs étanches.



NOTE: La distance maximale du fil entre le solénoïde et le SVC doit être de 30 mètres (fil de calibre AWG 18, Dia. 1 mm minimum).

Le SVC peut également piloter des solénoïdes autres que Hunter. Voici ci-dessous une liste de solénoïdes compatibles avec le SVC.

Modèle	Solénoïde
Baccara	G75-0-1002
Bermad	S392-2
Nelson	8090
Rain Bird	TBOSPSOL

MONTAGE DU SVC

Le SVC peut être monté facilement sur n'importe quelle vanne Hunter en matière plastique. Une bague de maintien spécialement conçue à cet effet permet le montage rapide du programmeur sur la vanne. Un cache en caoutchouc est fourni pour empêcher toute accumulation de saletés sur la face avant du SVC.

Montage du SVC sur une vanne (Figure 1)

1. Dévissez le solénoïde existant et le retirer de la vanne.
2. Vissez le solénoïde à verrouillage dans le chapeau de la vanne.
3. Accrochez le côté le plus grand de la bague de maintien à la partie centrale du boîtier du SVC.

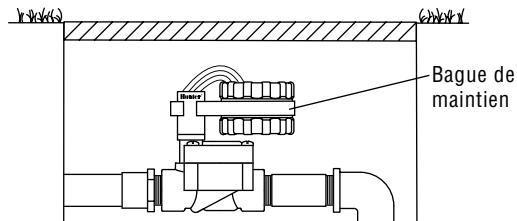

Figure 1

4. Accrochez le côté le plus petit de la bague de maintien au solénoïde.

Une bague de maintien universelle et un adaptateur de montage sont également fournis avec le SVC. Ces pièces permettent soit de fixer le programmeur sur le côté du regard soit de la monter sur un piquet à l'intérieur du regard d'arrosage.

Montage sur un côté du regard (Figure 2)

1. Positionnez l'adaptateur de montage universel sur le côté du regard. Pour choisir la position, assurez-vous que le programmeur une fois monté ne gênera pas la fermeture du couvercle du regard d'arrosage.
2. Utilisez deux vis pour fixer l'adaptateur sur le côté du regard.

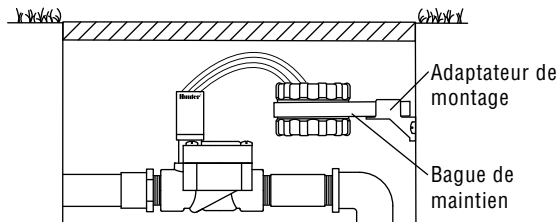

Figure 2

3. Accrochez la bague de maintien au SVC et glissez celle-ci dans l'extrémité de l'adaptateur de montage.

Montage sur piquet (Figure 3)

L'adaptateur de montage universel peut également être utilisé pour monter le SVC sur piquet.

1. Coupez un morceau de tube en matière plastique d'un diamètre de 13 mm.
2. Enfoncez le tube dans le sol à l'intérieur du regard d'arrosage jusqu'à la hauteur de montage du programmeur.
3. Glissez l'adaptateur de montage sur le tube.
4. Accrochez l'agrafe de verrouillage au SVC et glissez celle-ci dans l'adaptateur de montage.

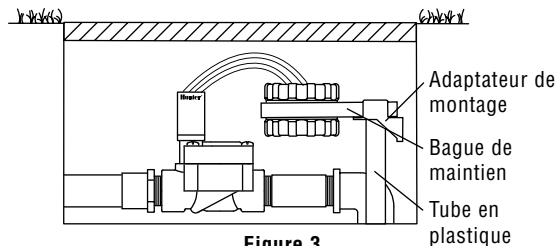

Figure 3

RACCORDEMENT D'UNE SONDE

Un pluviomètre Mini-Clik® de Hunter, ou tout autre type de sonde à microcontact, peut être connecté au SVC. Le but de la sonde est d'arrêter l'arrosage lorsque les conditions météorologiques l'imposent.



NOTE: Lorsque le pluviomètre interrompt l'arrosage, l'icône ☹️ indiquant la désactivation du système, « OFF » et l'icône ☂️ apparaissent sur l'affichage.



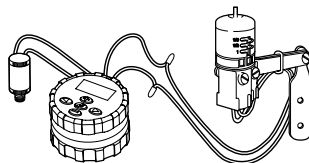



1. Coupez le fil jaune en boucle fixé au SVC approximativement au milieu de la boucle.
2. Dénudez les deux extrémités du fil sur environ 13 mm. Raccordez chacune de ces extrémités à un des deux fils du pluviomètre. Vous pouvez monter le capteur de pluie jusqu'à 30 mètres du programmeur SVC (fil de calibre AWG 18, Dia. 1 mm minimum).
3. Sécurisez les connexions au moyen de connecteurs étanches à l'eau.



Modèle Hunter Mini-Clik®













PROGRAMMATION

Le SVC utilise une programmation de station indépendante. Pour chaque station en cours de programmation, vous devez programmer au moins une heure de départ, un temps de fonctionnement et un jour d'arrosage. Le bouton  vous permet de vous déplacer rapidement parmi les options de programmation.

L'affichage du SVC indique l'heure et la date du jour lorsque vous appuyez sur le bouton . Le bouton  vous permet également de naviguer d'une option de programmation à l'autre. Lorsque vous ne touchez à aucun bouton, l'affichage s'éteint au bout d'un temps très court afin d'économiser la pile. En cours de programmation, vous pouvez modifier les indications qui clignotent en appuyant sur les boutons  et . Pour modifier une indication qui ne clignote pas, appuyez sur les boutons  et  pour vous déplacer jusqu'à la valeur à modifier.



Le SVC permet de programmer jusqu'à 9 départs de cycle d'arrosage. Ces départs multiples vous permettent de lancer l'arrosage le matin, l'après-midi et le soir, ce qui est parfait pour l'établissement de nouvelles pelouses ou l'arrosage de fleurs annuelles très gourmandes en eau. Indiquez simplement les jours de la semaine où vous souhaitez arroser, le SVC fait le reste.

Réglage de la date et de l'heure











1. Appuyez sur le bouton  jusqu'à ce que l'icône  représentant la date / heure actuelle soit affichée.
2. L'indication de l'heure clignote. Appuyez sur le bouton  ou  pour changer l'heure indiquée sur l'affichage. Appuyez sur le bouton  pour passer au réglage des minutes.
3. L'indication des minutes clignote. Appuyez sur le bouton  ou  pour changer les minutes indiquées sur l'affichage. Appuyez sur le bouton  pour passer à la sélection de AM, PM ou l'affichage sur 24 heures.
4. L'heure est affichée et l'heure du jour clignote. Appuyez sur le bouton  ou  pour sélectionner AM, PM ou 24 heures. Appuyez sur le bouton  pour passer au réglage du jour de la semaine.
5. Le chiffre 1 qui indique le premier jour de la semaine clignote. Appuyez sur le bouton  ou  pour sélectionner le chiffre (1 à 7) correspondant au jour de la semaine.

La date et l'heure sont maintenant réglées.



Réglage des départs de cycle d'arrosage

1. Appuyez sur le bouton  jusqu'à ce que l'icône  représentant l'heure de départ soit affichée. Le chiffre

situé directement à gauche de l'heure de départ de cycle (1 à 9) correspond au numéro de départ de cycle. Le numéro situé directement au-dessous du numéro de départ de cycle indique la station en cours de programmation.

- Utilisez le bouton  ou  pour changer l'heure de départ ; (l'heure de départ change par incréments de 5 minutes). Maintenez enfoncé l'un ou l'autre de ces boutons pour changer rapidement l'heure.
- Pour ajouter une autre heure de départ à la station, appuyez sur le bouton . L'icône heure de départ et le nombre d'heure de départ clignoteront. Utilisez les boutons  ou  pour modifier le nombre d'heure de départ.
- Appuyez sur le bouton . L'heure de départ se mettra à clignoter. Utilisez les boutons  ou  pour modifier l'heure de départ.
- Pour programmer des heures de départ pour une autre station, appuyez sur le bouton . Le numéro de station clignotera. Utilisez les boutons  ou  pour sélectionner la station suivante (1 à 4). Répétez les étapes 3 et 4.

Suppression d'un départ de cycle d'arrosage





Lorsque l'affichage est en mode heure de départ des cycles d'arrosage, appuyez sur le bouton  ou  pour afficher

12:00 AM (minuit). Appuyez alors une fois sur le bouton  pour afficher OFF.







NOTE: Si les 9 heures de départ de cycle d'arrosage sont toutes désactivées (OFF), alors le SVC lui-même est désactivé.



Réglage de la durée d'arrosage

- Appuyez sur le bouton  jusqu'à ce que l'icône  représentant la durée d'arrosage soit affichée.
- L'affichage indique la dernière durée d'arrosage programmée.
- Utilisez le bouton  ou  pour changer la durée d'arrosage de la station affichée et la régler entre 1 minute et 4 heures.
- Appuyez sur le bouton  pour vous déplacer au numéro de station suivant à programmer.

Réglage des jours d'arrosage





- Appuyez sur le bouton  jusqu'à ce que l'icône  représentant les jours d'arrosage soit affichée. Le numéro de la station sera alors indiqué.
- Le programmeur affiche les sept jours de la semaine avec l'icône  ou l'icône  au-dessus de chacun d'eux.

PROGRAMMATION (Suite)

L'icône  indique les jours « avec » arrosage, alors que l'icône  indique les jours « sans » arrosage.







3. Appuyez sur le bouton  pour vous déplacer au numéro de station suivant à programmer.

Sélection de jours de la semaine spécifiques avec arrosage

1. Le curseur  étant placé sur un jour spécifique (le curseur commence toujours par 1), appuyez sur le bouton  pour programmer le jour de la semaine concerné comme jour avec arrosage. Appuyez sur le bouton  pour annuler l'arrosage ce jour là. Une fois que vous avez appuyé sur l'un de ces boutons, le curseur passe automatiquement au jour suivant.
2. Répétez l'étape 1 pour tous les jours de la semaine que vous souhaitez programmer avec arrosage. Les jours sélectionnés apparaissent avec l'icône  qui indique que ces jours sont AVEC arrosage. La dernière icône  indique le dernier jour d'arrosage du programme.

→ Sélection d'un intervalle entre deux arrosages

Cette option vous permet de sélectionner un intervalle entre deux arrosages compris entre 1 et 31 jours.

1. Le curseur  étant placé sur le jour 7, appuyez sur le bouton  jusqu'à ce que l'icône  →  d'intervalle d'arrosage et les deux calendriers apparaissent sur l'affichage.
2. Appuyez sur le bouton  ou  pour sélectionner le nombre de jours (1 à 31) entre deux jours avec arrosage. Ce nombre sera l'intervalle d'arrosage.

Dans ce cas, le programmeur démarre l'arrosage à la prochaine heure de départ de cycle et arrosera selon l'intervalle d'arrosage programmé.

Programmation des stations pour un fonctionnement simultané



Le SVC-200 et le SVC-400 permettent un arrosage automatique de plusieurs vannes en même temps, jusqu'à un maximum de quatre. Si plus d'une station dispose de la même heure de départ, elles fonctionneront simultanément (elles doivent être également programmées avec le même jour d'arrosage). Par exemple, si les stations 1 et 2 ont toutes les deux été programmées avec les heures de départ de 8:00 AM, elles démarreront et fonctionneront en même temps.

Le SVC permet de mettre en attente des heures de départ ce qui est utile lorsque la capacité du système n'est pas étudiée pour supporter le fonctionnement de plusieurs vannes



en même temps. Considérons un scénario pour lequel la station 1 est programmée pour démarrer à 8:00 AM du matin, et pour fonctionner pendant 15 minutes, et que la station 2 est programmée pour démarrer à 8:10 AM et pour fonctionner également pendant 15 minutes. Le temps d'arrosage de la station 1 empiète sur l'heure de départ de la station 2. Le SVC attendra que la station 1 termine l'arrosage avant de faire démarrer la station 2. Dans ce cas précis, la station 2 démarrera à 8:15 AM.

Désactivation du système

Cette fonction vous permet d'arrêter le système pour une durée indéfinie.

1. Appuyez sur le bouton  jusqu'à ce que l'icône représentant un arroseur barré  soit affichée.
2. Attendez 4 secondes jusqu'à ce que « Off » apparaisse sur l'affichage. Le SVC est alors en mode système désactivé et le restera jusqu'à ce vous l'activiez de nouveau.





Réactivation du système lorsqu'il est désactivé

1. Appuyez une fois sur le bouton . L'affichage se rallume en mode Système désactivé.
2. Appuyez de nouveau sur le bouton de mode  pour faire disparaître l'indication « Off ». L'affichage donne

l'heure. Le programmeur est maintenant activé et contrôlera l'arrosage automatiquement selon le programme d'arrosage actuel.

Interruption d'arrosage programmable

Cette fonction vous permet d'interrompre tous les programmes d'arrosage pendant une période de temps donnée comprise entre 1 et 7 jours. A la fin de la période d'interruption d'arrosage programmée, le programmeur revient à son mode de fonctionnement normal.







1. Appuyez sur le bouton  jusqu'à ce que l'icône  indiquant que le système est désactivé soit affichée. Attendez 4 secondes et « Off » sera affiché.
2. Appuyez sur le bouton , le chiffre 1 s'affiche alors. Le 1 clignote à ce stade.
3. Appuyez sur le bouton  autant de fois que nécessaire pour programmer le nombre de jours souhaités (jusqu'à 7). Le SVC va attendre le nombre de jours sélectionnés et réactivera l'arrosage automatique.

Arrosage en mode manuel

Le SVC possède une touche pour l'arrosage en mode manuel. Une ou plusieurs stations peuvent être programmées pour être en marche manuelle simultanément.



PROGRAMMATION (Suite)

Pour activer l'arrosage manuel



1. Appuyez une fois sur le bouton  pour faire apparaître la date / heure actuelles.
2. Appuyez sur le bouton  et le maintenir enfoncé pendant deux secondes pour faire apparaître l'icône  représentant l'arrosage en mode manuel. Le numéro de la station est aussi affiché.
3. Utilisez le bouton  ou  pour régler la durée d'arrosage manuel entre 1 minute et 4 heures.
4. Relâchez les boutons et le programmateur activera le cycle d'arrosage manuel au bout de 10 secondes.
5. L'icône représentant un arroseur clignotant  apparaît sur l'affichage pour indiquer que l'arrosage est en cours.
6. Pour activer une autre station, utilisez le bouton  pour sélectionner la station que vous souhaitez utiliser pour arroser manuellement ; répétez les étapes 3 et 4.

Note: Pendant l'arrosage manuel, l'écran affichera brièvement le numéro de la station et le temps d'arrosage restant pour chaque station en fonctionnement. Le temps d'arrosage manuel peut être augmenté ou diminué tout le temps que la station est affichée.



Pour suspendre l'arrosage manuel sur toutes les stations en fonctionnement

1. Appuyez sur le bouton  jusqu'à ce que l'icône Système « OFF »  soit affichée. Attendez 4 secondes et « OFF » apparaîtra sur l'écran. Toutes les stations seront désactivées.
2. Appuyez une nouvelle fois sur le bouton  et la date et l'heure actuelles seront affichées. Le SVC réalisera alors l'arrosage en fonction du programme actuel.

Pour suspendre l'arrosage manuel sur des stations individuelles en fonctionnement

1. Appuyez sur le bouton  et l'écran affichera chacune des stations en fonctionnement manuel.
2. Lorsque le numéro de la station pour laquelle vous souhaitez suspendre l'arrosage manuel apparaît, appuyez une fois sur le bouton . Le temps restant affiché passera à « OFF » et la station sera désactivée.
3. Répétez les étapes 1 et 2 pour suspendre l'arrosage pour d'autres stations.

INDICATEUR DE DUREE DE VIE DE LA PILE

L'icône  représentant la pile est un moyen rapide de vérification de la durée de vie de la pile sans avoir à la sortir du programmeur. L'icône de représentation de l'état de la pile apparaît à côté de l'affichage de la date et de l'heure. Lorsque la pile est complètement rechargée les trois segments de l'icône  apparaissent en noir. Au fur et à mesure que la pile se décharge, les segments apparaîtront en clair .

GUIDE DE DEPANNAGE

PROBLÈME	CAUSES	SOLUTIONS
Il n'y a pas d'affichage.	L'affichage est désactivé. La pile est vide.	Appuyez sur n'importe quel bouton pendant 1 seconde. Remplacez la pile.
L'affichage indique que l'arrosage est en cours, mais aucun arrosage ne se produit.	Pas de pression d'eau. Le solénoïde est défectueux. Solénoïde incompatible	Ouvrez le circuit de distribution d'eau. Remplacez le solénoïde. Utilisez le solénoïde à impulsion Hunter (référence 458200) ou un autre solénoïde à impulsion compatible.
L'arrosage automatique ne démarre pas à l'heure de départ programmée.	Le programmeur est en mode système désactivé. L'heure actuelle n'a pas été réglée correctement. L'heure de départ de cycle n'a pas été réglée correctement.	Vérifiez que le programmeur est activé. Réglez correctement l'heure actuelle. Réglez correctement l'heure de départ de cycle.
Le pluviomètre n'arrête pas l'arrosage.	Le pluviomètre est défectueux ou mal connecté.	Vérifiez que le pluviomètre fonctionne correctement et qu'il est bien connecté.
Le programmeur démarre l'arrosage plus d'une fois.	Trop de départs de cycle ont été programmés (jusqu'à à 9 départs par jour).	Une heure de départ de cycle active un cycle complet d'arrosage. Programmez seulement une heure de départ de cycle si vous voulez arroser qu'une fois par jour.

SOMMARIO

Caratteristiche del programmatore SVC	44	Programmazione delle stazioni per il funzionamento congiunto	52
Componenti dei programmatori SVC.....	44	Disattivazione del sistema	53
Display LCD	44	Riattivazione del sistema disattivato	53
Pulsanti di comando	45	Interruzione di irrigazione programmabile.....	53
Installazione della batteria.....	46	Irrigazione in modo manuale	53
Cablaggio dei solenoidi	47	Sospensione manuale dell'irrigazione in tutte le stazioni in funzione	54
Montaggio della SVC	48	Sospensione manuale dell'irrigazione in una singola stazione	54
Montaggio dello SVC su una valvola	48	Indicatore di tempo di vita della batteria	55
Montaggio sul lato del pozzetto	48	Guida alla riparazione dei guasti.....	56
Montaggio su picchetto	49		
Raccordo di un pluviometro	49		
Programmazione	50		
Regolazione della data e dell'ora	50		
Regolazione delle partenze delle irrigazioni	50		
Annullamento dell'avvio di una irrigazione	51		
Regolazione della durata di funzionamento	51		
Regolazione dei giorni di irrigazione	51		
Selezione di giorni della settimana specifici con irrigazione	52		
Selezione dell'intervallo tra due irrigazioni.....	52		



CARATTERISTICHE DEL PROGRAMMATORE SVC

- Programmazione semplice tramite tasti
- Consente di comandare fino a quattro valvole
- Display a cristalli liquidi (LCD) di grandi dimensioni con icone intuitive
- Funzionamento a batteria alcalina standard da 9 V
- Programma di irrigazione specifico per giorni della settimana
- Fino a 9 partenze
- Tempi di funzionamento da 1 minuto a 4 ore
- Irrigazione manuale
- Indicatore batteria scarica che mostra la carica della batteria
- Compatibile con sensore pioggia (o altro sensore basato su microinterruttore)
- Opzioni di montaggio multiple
- La memoria non volatile conserva tutte le informazioni del programma

COMPONENTI DEI PROGRAMMATORI SVC

Questa sezione descrive brevemente alcuni componenti del programmatore SVC. Ciascun elemento verrà descritto dettagliatamente in seguito, tuttavia le informazioni fornite in questa sezione introducono le varie opzioni disponibili. Una caratteristica chiave del programmatore SVC è il design a tasti di facile utilizzo che semplifica le operazioni di programmazione.

Display LCD

1. **Display principale** – Indica tutte le informazioni programmate.
2. **Numero stazione** – Indica il numero della stazione che si sta programmando.
3.  **Giorno e ora** – L'icona indica che si stanno impostando il giorno e l'ora correnti.
4.  **Tempi d'irrigazione** – L'icona indica che si stanno impostando i tempi di esecuzione.
5.  **Partenze** – L'icona indica che si stanno impostando le partenze.
6. **Numero partenza** – Indica il numero della partenza impostata, da 1 a 9.

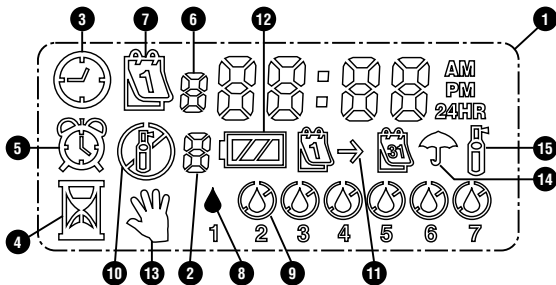

7. **Giorni d'irrigazione** – Consente all'utente di selezionare singoli giorni per l'irrigazione oppure un numero di giorni tra le irrigazioni (intervallo).
8. **Goccia** – Indica che l'irrigazione avverrà in un giorno selezionato.
9. **Goccia sbarrata** – Indica che l'irrigazione non avverrà in un giorno selezionato.
10. **Spento** – Indica che l'irrigazione è sospesa.
11. **Calendario** – Indica che si sta programmando l'intervallo di irrigazione. È possibile programmare da 1 a 31 giorni tra le operazioni di irrigazione.
12. **Stato della batteria** – Indica la carica rimanente nella batteria del programmatore SVC.
13. **Funzionamento manuale** – L'icona indica che è stata

programmata l'irrigazione manuale. È possibile attivare manualmente ogni stazione.

14. **Sensore Interrotto** – L'icona indica che il sensore pioggia ha fermato il sistema.
15. **Irrigazione in corso** – L'icona indica che è in corso l'irrigazione.

Pulsanti di comando

- Tasto** – Aumenta il display lampeggiante selezionato.
- Tasto** – Diminuisce il display lampeggiante selezionato.
- Tasto** – Seleziona la funzione di programmazione.
- Tasto** – Fa avanzare il display lampeggiante selezionato all'elemento successivo.
- Tasto** – Fa tornare il display lampeggiante selezionato all'elemento precedente.

INSTALLAZIONE DELLA BATTERIA

Lo SVC è alimentato da una pila alcalina a 9 V (non fornita), necessaria per poterlo programmare e per azionare la valvola. La durata della batteria è determinata dal numero di azionamenti della valvola; tuttavia in normali condizioni d'uso la pila dovrebbe fornire un'autonomia di almeno un anno.



NOTA: lo SVC contiene una memoria non volatile che permette di cambiare la batteria senza perdere le informazioni di programmazione.

Installazione della batteria

1. Svitare la parte posteriore del corpo del SVC per accedere al vano pila.
2. Installare la batteria nell'alloggiamento previsto.



NOTA: l'alloggiamento è fatto in modo da poter inserire la batteria in una sola direzione.

3. Accertarsi che non vi sia acqua nell'alloggiamento della pila. Riavvitare la parte posteriore del corpo per richiudere il programmatore. Unire ed avvitare le due metà dell'SVC per sigillare il pannello.

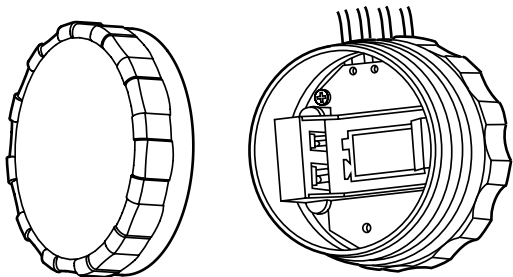

CABLAGGIO DEI SOLENOIDI

L'SVC-100 viene fornito con un solenoide applicato sul programmatore. I programmatori SVC-200 e SVC-400 multi-stazione sono in grado di gestire fino a 2-4 solenodi. I solenodi Hunter DC (P/N 458200) possono essere facilmente installati su tutte le valvole in plastica Hunter. I solenodi devono essere azionati separatamente. Per l'SVC-200 e l'SVC-400, i solenoide devono essere ordinati separatamente.



NOTA: utilizzare solo solenodi DC. I solenodi da 24V AC non funzionano con il programmatore SVC.

Filo comune (cavi neri)

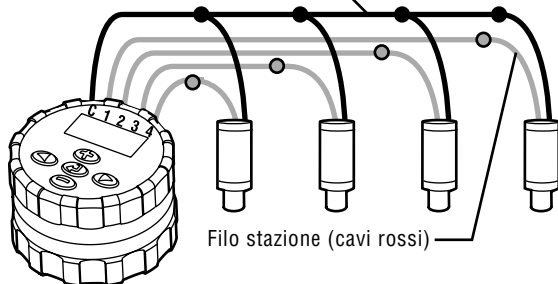

Per collegare solenodi DC al programmatore SVC

1. Collegare i cavi neri di ciascun solenoide al filo comune (cavo nero) del programmatore SVC. Fissare tutte le connessioni dei fili con connettori impermeabili.
2. Collegare un cavo rosso di ciascun solenoide al filo stazione corrispondente (cavi rossi) del programmatore SVC. I numeri delle stazioni sono identificati sulla parte anteriore del programmatore SVC. Fissare tutte le connessioni dei fili con connettori impermeabili.



NOTA: la distanza massima del filo tra il solenoide e il programmatore SVC è circa 30 metri (dimensione filo minima 18 gauge).

Il programmatore SVC può azionare anche solenodi DC non Hunter. Di seguito è riportato un elenco di solenodi compatibili con il programmatore SVC.

Modello	Solenoide
Baccara	G75-0-1002
Bermad	S392-2
Nelson	8090
Rain Bird	TBOSPSOL

MONTAGGIO DELLA SVC

Lo SVC può essere facilmente montato su qualsiasi valvola Hunter in plastica. Il montaggio del programmatore sulla valvola può essere effettuato rapidamente grazie all'anello di supporto appositamente previsto. In dotazione è fornita una protezione in gomma per impedire l'accumulo di sporco sulla parte anteriore dello SVC.

Montaggio dello SVC su una valvola (Figura 1)

1. Svitare il solenoide esistente (se a 24V) e toglierlo dalla valvola.
2. (P/N 458200) Avvitare il solenoide bistabile nel cappello della valvola.
3. Agganciare il lato più grande dell'anello di supporto alla parte centrale del corpo della SVC.



Figura 1

4. Agganciare il lato più piccolo dell'anello di supporto al solenoide.

Con lo SVC sono inoltre forniti in dotazione un anello di supporto ed un adattatore di montaggio universale. Questi pezzi consentono di fissare il programmatore sia sul lato del pozzetto che su un picchetto all'interno del pozzetto di irrigazione.

Montaggio sul lato del pozzetto (Figura 2)

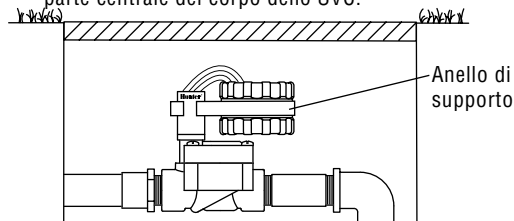
1. Posizionare l'adattatore di montaggio universale sul lato del pozzetto. Per scegliere la posizione, verificare che il programmatore, dopo il montaggio, non ostacoli la chiusura del coperchio del pozzetto di irrigazione.
2. Usare due viti per fissare l'adattatore sul lato del pozzetto.



Figura 2

3. Agganciare l'anello di supporto allo SVC e farlo scivolare nell'estremità dell'adattatore di montaggio.

Montaggio su picchetto (Figura 3)

L'adattatore universale di montaggio può anche essere usato per montare lo SVC su picchetto.

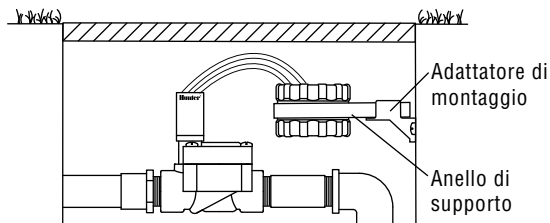
1. Tagliare un pezzo di tubo di plastica di diametro 13 mm.
2. Infilare il tubo nel terreno all'interno del pozzetto di irrigazione fino all'altezza di montaggio del programmatore.
3. Infilare l'adattatore di montaggio sul tubo.
4. Agganciare la graffa di fissaggio allo SVC ed infilarla nell'adattatore di montaggio



Figura 3

RACCORDO DI UN PLUVIOMETRO

Allo SVC può essere collegato un pluviometro Mini-Clik® Hunter o qualsiasi altro tipo di pluviometro a microcontatto. Il pluviometro ha la funzione di arrestare l'irrigazione quando le condizioni meteorologiche lo impongono.

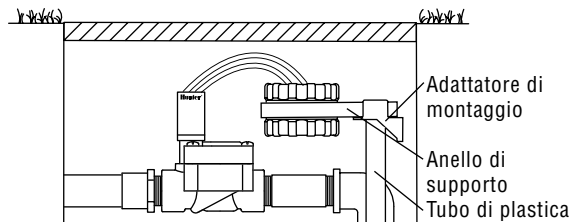

NOTA: quando il pluviometro interrompe l'irrigazione, sul display vengono visualizzate l'icona ☔ che indica la disattivazione del sistema "OFF" e l'icona ☂.



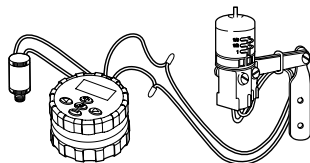



1. Tagliare il filo giallo intrecciato fissato allo SVC a circa metà della treccia.
2. Spellare le due estremità del filo per circa 13 mm. Raccordare ciascuna estremità ad uno dei due fili del pluviometro. È possibile montare un sensore pioggia fino a 30 metri di distanza dal programmatore SVC-400 (dimensione filo minima 18 GA).
3. Rendere sicure le connessioni utilizzando dei connettori impermeabili.



Mini-Clik® di Hunter













PROGRAMMAZIONE

Con il programmatore SVC è possibile programmare le stazioni indipendentemente tra loro. Per ciascuna stazione che viene programmata, occorre impostare almeno una Partenza, un Tempo di funzionamento e i Giorni di irrigazione. Il  pulsante consente di scorrere velocemente tra le opzioni di programmazione.

Premendo , il display dello SVC indica l'ora e la data del giorno. Il pulsante  permette inoltre di navigare tra le varie opzioni di programmazione. Dopo un piccolo lasso di tempo in cui non viene più effettuata alcuna operazione sui pulsanti, il display si spegne per non consumare la batteria. Durante la programmazione le indicazioni lampeggianti possono essere modificate premendo i pulsanti  e . Per modificare un'indicazione non attiva e spostarsi sul valore da modificare, premere i pulsanti  e .

Lo SVC consente di programmare fino a 9 partenze giornaliere. La possibilità di disporre di varie partenze permette di avviare l'irrigazione la mattina, il pomeriggio o la sera permettendo una irrigazione ideale per erba appena piantata o per fiori annuali che richiedono molta acqua. Indicare semplicemente i giorni della settimana in cui si desidera effettuare l'irrigazione. Lo SVC farà tutto il resto.

Regolazione della data e dell'ora











1. Premere il pulsante  fino a visualizzare l'icona  che rappresenta la data/ora.
2. L'indicazione dell'ora lampeggia. Premere il pulsante  o  per cambiare l'ora indicata sul display. Premere il pulsante  per passare alla regolazione dei minuti.
3. L'indicazione dei minuti lampeggia. Premere il pulsante  o  per cambiare i minuti indicati sul display. Premere il pulsante  per passare alla selezione delle ore antimeridiane (AM), pomeridiane (PM) o alla visualizzazione su 24 ore.
4. È visualizzata l'ora del giorno lampeggiante. Premere il pulsante  o  per selezionare AM, PM o 24 ore. Premere il pulsante  per passare alla regolazione del giorno della settimana.
5. Il numero 1 indica che il primo giorno della settimana lampeggia. Premere il pulsante  o  per selezionare il numero (da 1 a 7) corrispondente al giorno della settimana.

A questo punto la data e l'ora sono regolate.



Regolazione delle partenze delle irrigazioni

1. Premere il pulsante  fino a visualizzare l'icona  che rappresenta l'ora di partenza. Il tempo di avvio o

“Off” lampeggerà. Il numero immediatamente a sinistra del tempo di avvio (da 1 a 9) indica il codice relativo al tempo di avvio. Il numero immediatamente sottostante il codice relativo al tempo di avvio indica la stazione programmata.

2. Usare il pulsante  o  per cambiare la partenza (le partenze cambiano con incrementi di 15 minuti). Per cambiare velocemente tenere premuto l'uno o l'altro tasto.
3. Per aggiungere un'altra partenza per la stazione, premere il pulsante . L'icona che indica il numero della partenza (da 1 a 9) lampeggerà. Utilizzare il tasto  o  per modificare il numero della partenza.
4. Premere il pulsante . L'ora di partenza lampeggia. Utilizzare il tasto  o  per modificare l'ora di partenza.
5. Per programmare le partenze di un'altra stazione, premere il pulsante . Il numero della stazione lampeggia. Utilizzare il tasto  o  per selezionare la stazione successiva (da 1 a 4). Ripetere i passaggi 3 e 4.





Annullamento dell'avvio di una irrigazione

Quando il display si trova nel modo partenza dei cicli di irrigazione, premere il pulsante  o  per visualizzare 12.00 AM (mezzanotte). Poi premere una volta il pulsante  per visualizzare OFF.









Nota. Se le nove partenze sono disattivate (OFF) anche lo SVC sarà disattivato.

Regolazione della durata di funzionamento

1. Premere il pulsante  fino a visualizzare l'icona  che rappresenta la durata di irrigazione.
2. Il display indica l'ultima durata di irrigazione programmata.
3. Usare i pulsanti  o  per cambiare la durata di irrigazione della stazione visualizzata e regolarla tra 1 minuto e 4 ore.
4. Premere il pulsante  per passare al numero della prossima stazione da programmare. Sarà visualizzato anche il numero di stazione.





Regolazione dei giorni di irrigazione

1. Premere il pulsante  fino a visualizzare l'icona  che rappresenta i giorni di irrigazione.
2. Il programmatore visualizza i sette giorni della settimana con l'icona  oppure l'icona  sopra ciascuno di essi. L'icona  indica i giorni “con” irrigazione mentre l'icona  indica i giorni “senza” irrigazione.

PROGRAMMAZIONE (Segue)



3. Premere il pulsante  per passare al numero della prossima stazione da programmare.



Selezione di giorni della settimana specifici con irrigazione



1. Con il cursore  posizionato su un dato giorno (il cursore comincia sempre da 1), premere il pulsante  per programmare il giorno della settimana che si desidera definire come giorno di irrigazione. Premere il pulsante  per annullare l'irrigazione in quel giorno. Dopo aver premuto uno di questi bottoni il cursore passerà automaticamente al giorno seguente.
2. Ripetere la procedura 1 per tutti i giorni della settimana che si desidera programmare con irrigazione. I giorni selezionati appaiono con l'icona  che indica che si tratta di giorni CON irrigazione. L'ultima icona  indica l'ultimo giorno di irrigazione del programma.

→ Selezione dell'intervallo tra due irrigazioni

Questa opzione consente di selezionare un intervallo tra due irrigazioni compreso tra 1 e 31 giorni.

1. Con il cursore  posizionato sul giorno 7, premere il pulsante  fino a vedere apparire sul display l'icona

 →  di intervallo di irrigazione ed i due calendari.

2. Premere il pulsante  o  per selezionare il numero di giorni (da 1 a 31) tra due giorni di irrigazione. Il numero inserito sarà l'intervallo di irrigazione.



In questo caso il programmatore avvia l'irrigazione alla seguente ora di avvio di ciclo ed irrigherà secondo l'intervallo di irrigazione programmato.

Programmazione delle stazioni per il funzionamento congiunto



Il programmatore SVC-200 e l'SVC-400 consentono di partecipare automaticamente l'ora di inizio: ciò è utile quando la capacità del sistema non è adeguata per supportare il funzionamento di più valvole contemporaneamente. Ad esempio, la stazione 1 è programmata per iniziare l'irrigazione alle 8:00 AM e per funzionare per 15 minuti, mentre la stazione 2 è programmata per iniziare l'irrigazione alle 8:10 AM e per funzionare per 15 minuti. Il tempo di funzionamento dell'irrigazione della stazione 1 si sovrappone all'ora di inizio della stazione 2. Il programmatore SVC attenderà che la stazione 1 completi l'irrigazione prima di avviare la stazione 2. In questo caso, la stazione 2 inizierà l'irrigazione alle 8:15 AM.

Disattivazione del sistema

Questa funzione permette di fermare il sistema per un tempo indefinito.





1. Premere il pulsante  fino a visualizzare l'icona che rappresenta un irrigatore barrato .
2. Attendere 4 secondi fino a far comparire "Off" sul display. Lo SVC è disattivato e rimarrà tale fino a quando non verrà riattivato.

Riattivazione del sistema disattivato

1. Premere una volta il pulsante . Il display si riaccende in modo Sistema disattivato.
2. Premere nuovamente sul tasto di modo  per far scomparire l'indicazione "Off". Lo schermo mostrerà l'ora corrente. Il programmatore è di nuovo attivo e controllerà automaticamente l'irrigazione secondo il programma di irrigazione impostato.

Interruzione di irrigazione programmabile





Questa funzione permette di interrompere tutti i programmi di irrigazione per un dato periodo di tempo compreso tra 1 e 7 giorni. Alla fine del periodo di interruzione di irrigazione programmata il programmatore torna nel modo di funzionamento normale.

1. Premere il pulsante  fino a visualizzare l'icona  che indica che il sistema è disattivato. Attendere 4 secondi e sullo schermo apparirà il messaggio "off (spento)."
2. Premere il pulsante : viene visualizzato il numero 1, che lampeggia.
3. Premere il pulsante  il numero di volte necessario a programmare il numero di giorni desiderati (max 7). L'SVC attenderà il numero selezionato di giorni, trascorsi i quali riprenderà l'irrigazione automatica.



Irrigazione in modo manuale

L'SVC è dotato di un semplice avvio manuale "one touch". È possibile programmare una o più stazioni affinché funzionino contemporaneamente in modalità manuale.

Per attivare l'irrigazione manuale:



1. Premere una volta il pulsante  per visualizzare l'icona e l'ora attuali.
2. Premere il pulsante  e tenerlo premuto per due secondi per visualizzare l'icona  che rappresenta l'irrigazione in modo manuale. Sarà visualizzato anche il numero di stazione.
3. Usare il pulsante  o  per regolare la durata di irrigazione manuale tra 1 minuto e 4 ore.

PROGRAMMAZIONE (Segue)



4. Rilasciare i pulsanti: il programmatore farà partire l'irrigazione manuale dopo 10 secondi.
5. L'icona che rappresenta un irrigatore lampeggiante viene visualizzata sul display  per indicare che l'irrigazione è in corso.
6. Per attivare un'altra stazione, utilizzare il pulsante . Per selezionare la stazione desiderata per l'irrigazione manuale, ripetere i passaggi 3 e 4.

Nota: durante l'irrigazione manuale il display mostra brevemente il numero della stazione e il tempo di irrigazione rimanente per ogni stazione in funzione. Il tempo di funzionamento dell'irrigazione manuale può essere aumentato o diminuito finché la stazione è visualizzata.



Per sospendere l'irrigazione manuale di tutte le stazioni in funzione

1. Premere il tasto fino  a quando l'icona  Sistema OFF non viene visualizzata. Attendere 4 secondi e "OFF" apparirà sul display. Tutte le stazioni verranno spente.
2. Premere nuovamente il pulsante  e verranno visualizzati l'ora e il giorno correnti. Il programmatore SVC ora irrigherà in base al programma corrente.

Per sospendere l'irrigazione manuale di singole stazioni in funzione

1. Premere il pulsante  e il display mostrerà ciascuna delle stazioni in funzione manualmente.
2. Quando viene visualizzato il numero della stazione di cui si desidera sospendere l'irrigazione manuale, premere il pulsante  una volta. Il display del tempo rimasto mostra "Off" e la stazione viene disattivata.
3. Ripetere i passaggi 1 e 2 per sospendere l'irrigazione di altre stazioni.

INDICATORE DI TEMPO DI VITA DELLA BATTERIA

L'icona  che rappresenta la batteria costituisce un mezzo veloce per verificarne lo stato di carica senza doverla estrarre dal programmatore. L'icona di indicazione di carica della pila figura a fianco alla visualizzazione della data e dell'ora. Se la batteria è completamente carica i tre segmenti dell'icona  sono visualizzati in nero. Man mano che la pila si scarica i segmenti appaiono sempre più chiari .

GUIDA ALLA RIPARAZIONE DEI GUASTI

PROBLEMA	CAUSE	SOLUZIONI
Non c'è display.	Il display è disattivato. La pila è scarica.	Premere qualsiasi tasto per 1 secondo. Sostituire la pila.
Il display indica che l'irrigazione è in corso ma in realtà l'irrigazione non viene eseguita.	Mancanza di pressione d'acqua Il solenoide è difettoso. Solenoidi non compatibili.	Aprire il circuito di distribuzione dell'acqua. Sostituire il solenoide. È necessario utilizzare una valvola a solenoide CC di Hunter (P/N 458200) o un altro tipo di valvola a solenoide CC compatibile.
L'irrigazione automatica non parte all'ora programmata di partenza.	Il programmatore è in modo sistema disattivato. L'ora attuale non è stata regolata correttamente. L'ora di partenza dell'irrigazione non è stata regolata correttamente.	Verificare che il programmatore sia attivato. Regolare l'ora attuale. Regolare l'ora di partenza.
Il pluviometro non arresta l'irrigazione.	Il pluviometro è difettoso oppure collegato male.	Verificare che il pluviometro funzioni correttamente e che sia correttamente collegato.
Il programmatore avvia l'irrigazione più di una volta.	Sono state programmate troppe partenze (fino a 9 tempi di avvio giornalieri).	Un'orario di partenza attiva una irrigazione in una valvola. Vedere "Regolazione delle partenze delle irrigazioni". Impostare solamente un tempo di avvio per avere una sola irrigazione in una valvola.

INHALTSÜBERSICHT

SVC Eigenschaften	58	Programmierung von Stationen für den gemeinsamen Betrieb	66
SVC Komponenten	58	Deaktivierung des Systems	67
LCD Display	58	Neuaktivierung des Systems, wenn es deaktiviert ist	67
Kontrolltasten	59	Programmierbare Unterbrechung der Beregnung	67
Einsetzen der Batterie	60	Beregnung in manueller Betriebsart	68
Anschluss einer DC Impulsspule	61	Abstellung der manuellen Bewässerung aller sich im Betrieb befindlichen Stationen	68
Montage des SVC	62	Abstellung der manuellen Bewässerung einzelner Stationen	68
Montage des SVC an einem Magnetventi	62	Anzeige für die Lebensdauer der Batterie	69
Montage auf einer Seite des Kontrollschachtes	62	Abhilfe bei Störungen	70
Montage an einem Rohrstück	63		
Anschluss eines Niederschlagsmessers	63		
Programmierung	64		
Einstellung von Datum und Uhrzeit	64		
Einstellung des Beginns der Beregnungszyklen	65		
Löschen eines Beginns der Beregnungszyklen	65		
Einstellung der Beregnungsdauer	65		
Einstellung der Beregnungstage	65		
Wahl von spezifischen Wochentagen mit Beregnung	66		
Wahl eines Abstands zwischen zwei Beregnungen	66		





SVC EIGENSCHAFTEN

- Einfache Programmierung durch Drucktasten
- Betrieb mit bis zu vier Ventilen
- Großes Liquid Crystal Display (LCD) mit leicht zu verstehenden Symbolen
- Betrieb mit einer normalen 9-Volt Alkalibatterie
- Wochentag-Bewässerungsprogramm
- Bis zu neun Startzeiten pro Tag
- Laufzeiten von 1 Minute bis zu 4 Stunden
- Manuelle Bewässerung
- Batteriezustand zeigt die verbleibende Lebensdauer der Batterie an
- Mit Regensensor (oder sonstigem Mikroschalter-Sensor) kompatibel
- Vielfache Montagemöglichkeiten
- Im permanenten Speicher werden sämtliche Programminformationen gespeichert

SVC KOMPONENTEN

In diesem Abschnitt finden Sie einen kurzen Überblick über einige Komponenten des SVC, wobei jeder Punkt später ausführlicher behandelt wird. Dieser Abschnitt kann sich als hilfreich erweisen, um die verschiedenen erhältlichen Optionen kennen zu lernen.

LCD Display

1. **Hauptdisplay** – Zeigt die vollständige einprogrammierte Information an.
2. **Stationsnummer** – Zeigt die einprogrammierte Stationsnummer an.
3.  **Aktuelle Zeit / Tag** – Durch dieses Symbol ist die Einstellung des aktuellen Tags bzw. Zeit zu erkennen.
4.  **Laufzeit** – Durch dieses Symbol ist die eingestellte Laufzeit zu erkennen.
5.  **Startzeit** – Durch dieses Symbol ist die eingestellte Startzeit zu erkennen.
6. **Startzeit-Nummer** – Zeigt die Startzeit-Nummer von 1 bis 9 an.
7.  **Bewässerungstage** – Erlaubt dem Benutzer individuell die Bewässerungstage bzw. die Anzahl der Tage zwischen den einzelnen Bewässerungen einzustellen (Intervall).

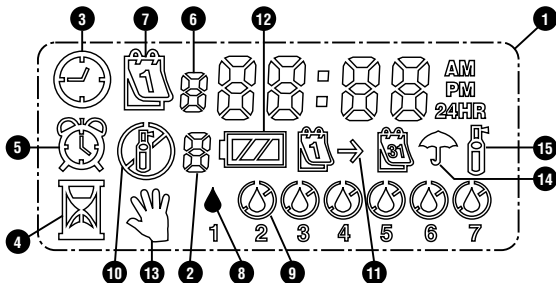

8. **Regentropfen** – Zeigt an, dass die Bewässerung an einem bestimmten Tag stattfindet.
9. **Gekreuzter Regentropfen** – Zeigt an, dass die Bewässerung nicht an einem bestimmten Tag stattfindet.
10. **Gekreuzter Regner** – Zeigt die Unterbrechung der Bewässerung an.
11. **Kalender** – Zeigt an, dass das Intervallbewässerungsprogramm eingestellt ist. Erlaubt dem Benutzer zwischen 1 und 31 bewässerungsfreie Tage einzustellen.
12. **Batteriezustand** – Zeigt die verbleibende Lebensdauer der Batterie des SVC an.
13. **Manuelle Bewässerung** – Durch dieses Symbol wird angezeigt, dass die manuelle Bewässerung programmiert ist. Erlaubt dem Benutzer, die Station von

Hand zu aktivieren.

14. **Regenschirm** – Dieses Symbol zeigt an, dass der Regensensor das System automatisch deaktiviert hat.
15. **Regner aufleuchten** – Dieses Symbol zeigt an, dass die Bewässerung angestellt ist.

Kontrolltasten

- Taste** – Erhöht den im Display aufblinkenden Wert.
- Taste** – Reduziert den im Display aufblinkenden Wert.
- Taste** – Wählt Programmfunktionen aus.
- Taste** – Rückt den ausgewählten, aufblinkenden Wert im Display in die nächste Position vor.
- Taste** – Führt den ausgewählten, aufblinkenden Wert im Display in die vorherige Position zurück.

EINSETZEN DER BATTERIE

Die Versorgung des SVC-Geräts erfolgt mit Hilfe einer 9 Volt Alkalibatterie (nicht mitgeliefert), die für die Programmierung des Geräts und die Betätigung des Magnetventils erforderlich ist. Die Lebensdauer der Batterie hängt von der Anzahl der Ventilbetätigungen ab. Jedoch dürfte sie unter normalen Betriebsbedingungen eine Funktion von mindestens einem Jahr gewährleisten.



ANMERKUNG: Das SVC-Gerät enthält einen nicht flüchtigen Speicher, der es ermöglicht, die Batterie ohne Verlust der programmierten Informationen auszuwechseln.

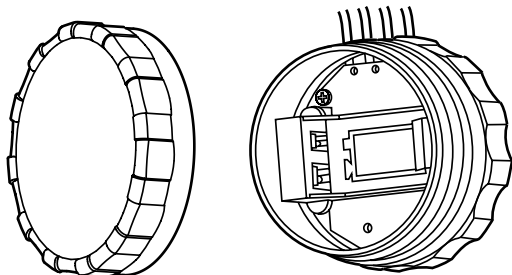

Einsetzen der Batterie

1. Den rückwärtigen Teil des SCV-Gehäuses abschrauben, um zum Einbauort der Batterie zu gelangen.
2. Die Batterie einsetzen.



ANMERKUNG: Der Einbauort der Batterie ist so ausgelegt, dass sie nur auf eine bestimmte Art eingesetzt werden kann.

3. Überprüfen, dass im Einbauort der Batterie kein Wasser vorhanden ist. Den rückwärtigen Teil des Gehäuses verschrauben, um das Steuergerät zu schließen. Schrauben Sie die SVC Körperhälften zusammen, um das Fach zu versiegeln.

ANSCHLUSS EINER DC IMPULSSPULE

Der SVC-100 ist mit einer am Steuergerät angebrachten Spule ausgestattet. Die SVC-200 und SVC-400 Multi-sektions-Steuergeräte bedienen bis zu 2 oder 4 Spulen. Das SVC-400 ist so ausgestattet, dass es mit bis zu vier individuellen DC Impulsspulen arbeiten kann. Hunter DC Magnete (P/N 458200) können leicht auf alle Hunter Kunststoffventile installiert werden. Für die Modelle SVC-200 und SVC-400 müssen die Spulen separat bestellt werden.



HINWEIS: Es müssen DC Selbst-Halte-Magnete verwendet werden. 24VAC Magnete können nicht mit dem SVC angesteuert werden.

Normales Kabel (schwarze Leitung)

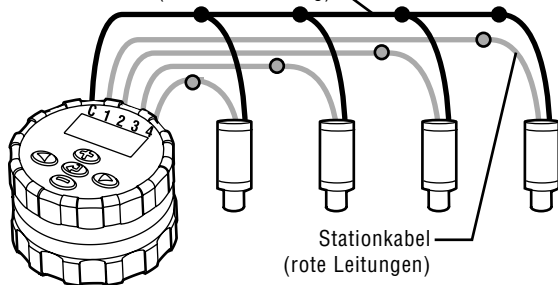

Verkabelung des DC Magnets an das SVC

1. Verbinden Sie die schwarzen Leitungen der Magnete mit dem Gemeinschaftskabel (schwarz) des SVC . Verwenden Sie hierzu wasserresistente Kabelverbinder.
2. Verbinden Sie jeweils ein rotes Kabel von jedem Magneten an das entsprechende Stationskabel (rot) des SVC. Die Stationsnummer wird auf der Vorderseite des SVC angegeben. Verwenden Sie hierzu wasserdichte Kabelverbinder.



HINWEIS: Die maximale Kabellänge zwischen den Magneten und dem SVC beträgt 30 Meter (1mm minimale Kabelgröße).

Das SVC kann ebenso mit DC Magnetspulen anderer Hersteller betrieben werden. Nachfolgend finden Sie eine Liste mit SVC kompatiblen Magneten.

Modell	Magnet
Baccara	G75-0-1002
Bermad	S392-2
Nelson	8090
Rain Bird	TBOSPSOL

MONTAGE DES SVC

Das SVC-Gerät kann leicht an jedem Hunter-Magnetventil aus Kunststoff montiert werden. Ein speziell hierfür ausgelegter Klemmring ermöglicht die rasche Montage des Steuergeräts am Magnetventil. Eine Gummiabdeckung wird mitgeliefert, um jegliche Ansammlung von Schmutz auf der Vorderseite des SVC zu vermeiden.

Montage des SVC an einem Magnetventil (Abbildung 1)

1. Die vorhandene Spule abschrauben und von dem Magnetventil entfernen.
2. Die mitgelieferte Spule in den Ventildeckel schrauben.
3. Die größere Seite des Klemmrings am mittleren Teil des SVC-Gehäuses einhängen.



Abbildung 1

4. Die kleinere Seite des Klemmrings an der Spule einhängen.

Ein Klemmring sowie ein Universal-Montageadapter werden ebenfalls mit dem SVC-Gerät geliefert. Diese Teile ermöglichen es, das Steuergerät entweder auf der Seite des Kontrollschachtes oder an einem Rohrstück im Beregnungs-Kontrollschacht zu montieren.

Montage auf einer Seite des Kontrollschachtes (Abbildung 2)

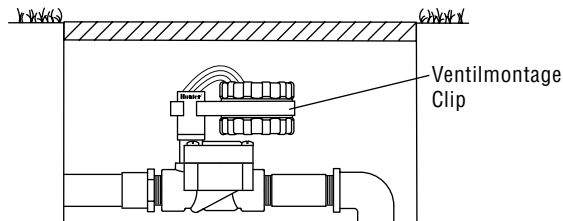
1. Den Universal-Montageadapter auf der Seite des Kontrollschachtes positionieren. Vergewissern Sie sich bei der Wahl der Position, dass das Steuergerät nach seiner Montage das Schließen des Deckels des Beregnungs-Kontrollschachtes nicht behindert.
2. Zwei Schrauben verwenden, um den Adapter auf der



Abbildung 2

Seite des Kontrollschachtes zu befestigen.

- Den Klemmring am SVC einhängen und in das Endstück des Montageadapters schieben.

Montage an einem Rohrstück (Abbildung 3)

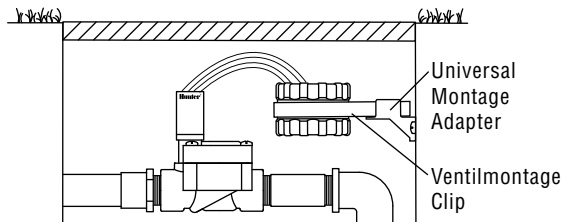
Der Universal-Montageadapter kann ebenfalls für die Montage des SVC an einem Rohrstück verwendet werden.

- Ein Stück Rohr aus Kunststoff mit einem Durchmesser von 13 mm oder $\frac{1}{2}$ " abschneiden.
- Das Rohr im Beregnungs-Kontrollschacht bis zur Montagehöhe des Steuergeräts in den Boden stecken.
- Den Montageadapter auf das Rohr schieben.
- Die Sperrklammer am SVC einhängen und in den Montageadapter schieben.



Abbildung 3

ANSCHLUSS EINES NIEDERSCHLAGSMESSERS

Ein Niederschlagsmesser Mini-Click® von Hunter oder jeder andere Niederschlagsmessertyp mit einem Mikroschalter kann an das SVC-Gerät angeschlossen werden. Dieser Niederschlagsmesser bezweckt das Abstellen der Beregnung, wenn die klimatischen Bedingungen dies erfordern.

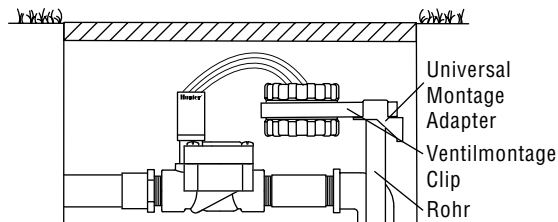

ANMERKUNG: Wenn der Niederschlagsmesser die Beregnung unterbricht, erscheint das Symbol  für die Deaktivierung des Systems, „OFF“ sowie das Symbol  an der Anzeige.



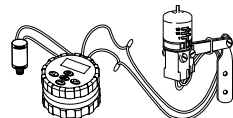



- Den gelben, mit einer Schleife am SVC befestigten Draht ungefähr in der Mitte der Schleife durchschneiden.
- Die beiden Drahtenden über ca. 13 mm abisolieren. Jedes Endstück an einen der beiden Drähte des Niederschlagsmessers anschließen. Der Regensensor kann in einer Entfernung von etwa 30 Meter zum SVC-400 Steuergerät montiert werden (1 mm² minimale Kabelgröße).
- Die Verbindungen mit wasserdichten Kabelverbindern ausführen.



Hunter Modell Mini-Click®













PROGRAMMIERUNG

Das SVC verwendet eine unabhängige Stationsprogrammierung. Für jede zu programmierende Station muss die Startzeit, eine Laufzeit sowie der / die Bewässerungstag(e) einprogrammiert werden. Mit Hilfe der Taste  können Sie schnell zwischen den Programmoptionen hin- und herschalten.

Durch Druck auf die Taste  erscheinen die Uhrzeit und das Datum auf der Anzeige des SVC. Die Taste  ermöglicht ebenfalls die Navigation von einer Programmierungsoption zur anderen. Wird keine Taste betätigt, erlischt die Anzeige nach einer sehr kurzen Zeit, um die Batterie zu schonen. Während der Programmierung können die blinkenden Angaben durch Druck auf die Tasten  oder  und geändert werden. Zur Änderung einer nicht blinkenden Angabe ist der Druck auf die Tasten  oder  erforderlich, um den zu ändernden Wert zu erreichen.

Das SVC-Gerät gestattet eine Programmierung bis zu 9 Zyklusstarts zur Beregnung. Diese mehrfachen Startmöglichkeiten erlauben einen Beregnungsbeginn am Morgen, Nachmittag und am Abend, was besonders für neu angelegte Rasenflächen oder die Beregnung von Blumen mit großem Wasserbedarf günstig ist. Es genügt, die Wochentage für die gewünschte Beregnung anzugeben, das SVC-Gerät übernimmt die Arbeit.

Einstellung von Datum und Uhrzeit



1. Auf die Taste  drücken, bis das Symbol  für die Darstellung des Datums / der aktuellen Uhrzeit erscheint.
2. Die Angabe der Stunden blinkt. Durch Druck auf die Taste  oder  kann die auf der Anzeige angegebene Stunde geändert werden. Mit einem Druck auf die Taste  erfolgt der Übergang zur Einstellung der Minuten.
3. Die Angabe der Minuten blinkt. Durch Druck auf die Taste  oder  kann die auf der Anzeige angegebene Minute geändert werden. Mit einem Druck auf die Taste  erfolgt der Übergang zur Wahl von AM, PM oder die Anzeige über 24 Stunden.
4. Die Uhrzeit wird angezeigt, und die Uhrzeit des Tages blinkt. Durch Druck auf die Taste  oder  kann AM, PM oder 24 Stunden gewählt werden. Mit einem Druck auf die Taste  erfolgt der Übergang zur Einstellung des Wochentages.
5. Die Ziffer 1 für die Angabe des ersten Tages der Woche blinkt. Durch Druck auf die Taste  oder  kann die Ziffer (1 bis 7) für den entsprechenden Wochentag ausgewählt werden.

Datum und Uhrzeit sind nun eingestellt.

Einstellung des Beginns der Berechnungszyklen

1. Auf die Taste  drücken, bis das  Symbol für die Darstellung der Uhrzeit für den Berechnungsbeginn erscheint. Es blinkt eine Startzeit oder "Off" auf. Die Zahl direkt links neben der Startzeit (zwischen 1 und 9) gibt die Startzeitnummer an. Die Zahl direkt unter der Startzeitnummer gibt die einprogrammierte Station an.
2. Mit Hilfe der Taste  oder  kann die Startzeit geändert werden (die Uhrzeit des Berechnungsbeginns ändert sich in Schritten von 5 Minuten). Bleibt entweder die eine oder die andere Taste gedrückt, erfolgt eine rasche Änderung der Uhrzeit.
3. Zur Einstellung einer neuen Startzeit in der Station drücken Sie die Taste . Das Startzeitsymbol und die Startzeit-Nummer blinken auf. Mit den  oder  Tasten kann die Startzeit-Nummer geändert werden.
4. Drücken Sie die Taste . Die Startzeit blinkt auf. Mit den Tasten  oder  kann die Startzeit geändert werden.
5. Zur Programmierung der Startzeit einer anderen Station drücken Sie die Taste . Es blinkt die Stationsnummer auf. Wählen Sie an Hand der Tasten  oder  die nächste Station (1 bis 4). Wiederholen Sie die Schritte 3 und 4.





Löschen eines Beginns der Berechnungszyklen

Befindet sich die Anzeige in der Betriebsart 'Uhrzeit für den Berechnungsbeginn' wird durch Druck auf die Taste  oder  12:00 AM (Mitternacht) angezeigt. Bei einem Druck auf die Taste  erscheint dann die Anzeige OFF.





ANMERKUNG: Wenn alle 9 Startzeiten der Berechnungszyklen deaktiviert sind (OFF), dann ist das SVC-Gerät außer Betrieb.

Einstellung der Berechnungsdauer





1. Auf die Taste  drücken, bis das Symbol  für die Darstellung der Berechnungsdauer erscheint.
2. Die Anzeige gibt die letzte programmierte Berechnungsdauer an.
3. Mit Hilfe der Taste  oder  kann die Berechnungsdauer der angezeigten Station geändert und zwischen 1 Minute und 4 Stunden eingestellt werden.
4. Drücken Sie die Taste , um zur nächsten zu programmierenden Stationsnummer zu gelangen.

Einstellung der Berechnungstage





1. Auf die Taste  drücken, bis das  Symbol für die Darstellung der Berechnungstage erscheint. Es erscheint

PROGRAMMIERUNG (Fortsetzung)

außerdem die Sektionsnummer.





2. Das Steuergerät zeigt die sieben Wochentage mit dem Symbol  oder dem Symbol  über jedem der Tage an. Das Symbol  gilt für die Tage „mit“ Berechnung und das Symbol  für die Tage „ohne“ Berechnung.
3. Drücken Sie die Taste , um zur nächsten zu programmierenden Stationsnummer zu gelangen.

Wahl von spezifischen Wochentagen mit Berechnung

1. Befindet sich der Cursor  auf einem spezifischen Tag (der Cursor beginnt immer mit 1), erfolgt durch Druck auf die Taste  die Programmierung des entsprechenden Wochentages als Tag mit Berechnung. Ein Druck auf die Taste  annulliert die Berechnung an diesem Tag. Nach einem Druck auf eine dieser Tasten geht der Cursor automatisch zum nächsten Tag über.
2. Der Schritt 1 ist für alle Tage der Woche zu wiederholen, die mit Berechnung programmiert werden sollen. Die gewählten Tage erscheinen mit dem Symbol , welches anzeigt, dass es sich um Tage mit Berechnung handelt. Die letzte Symbol  zeigt den letzten Berechnungstag des Programms an.

→ Wahl eines Abstands zwischen zwei Berechnungen

Mit Hilfe dieser Option besteht die Möglichkeit, einen Zeitabstand von 1 bis 31 Tagen zwischen zwei Berechnungstagen zu wählen.

1. Wenn sich der Cursor auf Tag 7 befindet, ist so lange auf die Taste  zu drücken, bis das Symbol  →  für den Berechnungsabstand und die beiden Kalender an der Anzeige erscheinen.
2. Auf die Taste  oder  drücken, um die Anzahl der Tage (1 bis 31) zwischen zwei Tagen mit Berechnung zu wählen. Diese Zahl entspricht dann dem Abstand der Berechnungstage.

In diesem Fall startet das Steuergerät die Berechnung bei der nächsten Zyklus-Startzeit, und die Berechnung erfolgt nach dem programmierten Berechnungsabstand.

Programmierung von Stationen für den gemeinsamen Betrieb (SVC-200 und SVC-400)



Die SVC-200 und SVC-400 ermöglichen eine automatische Bewässerung durch gleichzeitiges Öffnen mehrerer Ventile. Es können bis zu vier Stationen gleichzeitig in Betrieb genommen werden. Falls mehr als eine Station dieselbe Startzeit hat, sind sie gleichzeitig in Betrieb (sie müssen außerdem auf den gleichen Bewässerungstag einprogram-

miert sein). Wenn zum Beispiel die Startzeiten der Stationen 1 und 2 auf 8:00 AM einprogrammiert sind, schalten sie sich gleichzeitig an und sind gemeinsam in Betrieb.

Bei dem SVC kann die Startzeit gestaffelt werden, was sehr hilfreich ist, sofern die Kapazität des Systems den gemeinsamen Betrieb von mehreren Ventilen zur gleichen Zeit nicht unterstützt. Es soll folgende Möglichkeit angenommen werden: Die Startzeit der Station 1 ist 8:00 AM, die Laufzeit beträgt 15 Minuten und die Startzeit der Station 2 ist 8:10 AM und die Laufzeit beträgt ebenfalls 15 Minuten. Die Bewässerungszeit der Station 1 überlappt sich mit der Startzeit der Station 2. SVC wartet in einem solchen Fall mit dem Start der Station 2, bis die Bewässerungszeit der Station 1 vollständig abgelaufen ist. Folglich startet Station 2 um 8:15 AM.



Deaktivierung des Systems

Das System kann mit Hilfe dieser Funktion für eine unbestimmte Dauer abgestellt werden.

1. Auf die Taste  drücken, bis das Symbol mit der Darstellung eines durchgestrichenen Regners  erscheint.
2. 4 Sekunden warten, bis „Off“ an der Anzeige erscheint. Auf dem Display erscheint die aktuelle Uhrzeit. Das





SVC-Gerät befindet sich nun in der Betriebsart ‘System deaktiviert’, in dem es so lange bleibt, bis es erneut aktiviert wird.

Neuaktivierung des Systems, wenn es deaktiviert ist

1. Einmal auf die Taste  drücken. Die Anzeige schaltet sich in der Betriebsart ‘System entaktiviert’ ein.
2. Erneut auf die Taste der Betriebsart  drücken, damit die Angabe „Off“ verschwindet. Das Steuergerät ist nun aktiviert und überwacht automatisch die Beregnung nach dem aktuellen Beregnungsprogramm.

Programmierbare Unterbrechung der Beregnung

Diese Funktion ermöglicht, alle Beregnungsprogramme für eine bestimmte Zeitdauer zwischen 1 und 7 Tagen zu unterbrechen. Am Ende der programmierten Periode zur Beregnungsunterbrechung kommt das Steuergerät wieder zu seiner normalen Betriebsart zurück.

1. Auf die Taste  drücken, bis das Symbol  für die Deaktivierung des Systems angezeigt wird. Warten Sie 4 Sekunden, dann erscheint „Off“ auf dem Display.
2. Auf die Taste  drücken, es wird die Ziffer 1 angezeigt. Die Ziffer 1 blinkt.
3. So oft als erforderlich auf die Taste  drücken, um die





PROGRAMMIERUNG (Fortsetzung)



gewünschte Anzahl der Tage (bis zu 7) zu programmieren. Der SVC wartet die gewählte Tagesanzahl ab und reaktiviert dann die automatische Bewässerung.

Beregnung in manueller Betriebsart

Der SVC ist mit einer einfachen manuellen „One Touch“-Startfunktion ausgestattet. Er kann so programmiert werden, dass eine oder mehrere Sektionen manuell zur selben Zeit laufen.



Zur Aktivierung der manuellen Beregnung:

1. Klicken Sie einmal auf  und die aktuelle Uhrzeit anzuzeigen.
2. Auf die Taste  drücken und sie zwei Sekunden lang gedrückt halten, damit das Symbol  für die Darstellung der Beregnung in manueller Betriebsart erscheint.
3. Die Taste  oder  verwenden, um die Dauer der manuellen Beregnung zwischen 1 Minute und 4 Stunden einzustellen.
4. Die Tasten loslassen, das Steuergerät aktiviert dann den manuellen Beregnungszyklus nach 10 Sekunden.



5. Das Symbol  mit der Darstellung eines blinkenden Regners erscheint auf der Anzeige, um anzugeben, dass die Beregnung in Betrieb ist.
6. Zur Aktivierung einer weiteren Station drücken Sie die Taste , um die Station auszuwählen, die manuell bewässern soll, wiederholen Sie die Schritte 3 und 4.

Hinweis: Während der manuellen Bewässerung wird die Stationsnummer sowie die für die sich im Betrieb befindliche Station verbleibende Bewässerungszeit kurz im Display angezeigt. Die manuelle Bewässerungslaufzeit kann für die von der Station angezeigte Zeit verlängert oder verkürzt werden.



Abstellung der manuellen Bewässerung aller sich im Betrieb befindlichen Stationen

1. Drücken Sie die Taste , bis das System Aus / Off Symbol  angezeigt wird. Warten Sie 4 Sekunden und „OFF“ erscheint auf dem Display. Alle Stationen schalten sich ab.
2. Drücken Sie die Taste  erneut und es wird die momentane Zeit und der entsprechende Tag angezeigt. Des SVC wird nun gemäß des derzeitigen Programms bewässern.

Abstellung der manuellen Bewässerung einzelner Stationen

1. Drücken Sie die Taste  und es wird jede der manuell betriebenen Stationen angezeigt.
2. Sobald die Stationsnummer der Station erscheint, deren manuelle Bewässerung ausgestellt werden soll, drücken Sie die Taste  einmal. Die angezeigte verbleibende Zeit wechselt auf „Off“ und die Station schaltet sich aus.
3. Wiederholen Sie die Schritte 1 und 2, um weitere Stationen abzustellen.

ANZEIGE FÜR DIE LEBENSDAUER DER BATTERIE

Das Symbol  mit der Darstellung der Batterie ist ein rasches Hilfsmittel zur Überprüfung des aktuellen Batteriezustands, ohne diese aus dem Steuergerät nehmen zu müssen. Das Symbol für die Darstellung des Batteriezustands erscheint neben der Anzeige des Datums und der Uhrzeit. Ist die Batterie vollständig aufgeladen, sind die drei Segmente in dem Symbol  schwarz. Bei Entladen der Batterie werden die Segmente in dem Symbol  immer heller.

ABHILFE BEI STÖRUNGEN

PROBLEM	URSACHE	LÖSUNGEN
Keine Anzeige vorhanden.	Die Anzeige ist deaktiviert. Die Batterie ist entladen.	1 Sekunde lang auf eine beliebige Taste drücken. Batterie auswechseln.
Die Anzeige gibt an, dass die Beregnung in Betrieb ist, aber die Beregnung erfolgt nicht.	Kein Wasserdruck. Die Spule ist fehlerhaft. Spule inkompatibel.	Wasser-Zuleitung öffnen. Spule auswechseln. Sie müssen eine Hunter DC Spule (P/N 458200) oder eine kompatible DC Spule verwenden.
Die automatische Beregnung startet nicht zu der programmierten Uhrzeit für den Beginn.	Das Steuergerät befindet sich in der Betriebsart 'System deaktiviert'. Die aktuelle Uhrzeit wurde nicht korrekt eingestellt. Die Uhrzeit für den Zyklusstart wurde nicht korrekt eingestellt.	Sich vergewissern, dass das Steuergerät aktiviert ist. Die aktuelle Uhrzeit korrekt einstellen. Die Uhrzeit für den Zyklusstart korrekt einstellen.
Der Niederschlagsmesser stellt die Beregnung nicht ab.	Der Niederschlagsmesser ist fehlerhaft oder nicht korrekt angeschlossen.	Überprüfen, dass der Niederschlagsmesser korrekt funktioniert und angeschlossen ist.
Das Steuergerät startet die Beregnung mehr als ein Mal.	Es wurden zu viele Zyklusstarts programmiert (Bis zu 9 Startzeiten pro Tag).	Eine Uhrzeit für einen Zyklusbeginn aktiviert einen vollständigen Beregnungszyklus (siehe „Einstellung der Uhrzeiten für den Beginn der Beregnungszyklen“). Stellen Sie, wenn einmal am Tag gewässert werden soll, nur eine Startzeit ein.

SUMÁRIO

Características do SVC.....	72	Programação de Estações para que Funcionem em Conjunto (SVC-200 o SVC-400).....	80
Componentes SVC.....	72	Desactivação do sistema	81
Visor LCD.....	72	Reactivação do sistema após a desactivação	81
Botões de Controlo	73	Interrupção de rega programável	81
Instalação da Pilha	74	Rega em modo manual	81
Instalação dos Solenóides.....	75	Para Suspender a Rega Manual em Todas as Estações em Funcionamento	82
Montando o SVC	76	Para Suspender a Rega Manual em Estações Concretas em Funcionamento	82
Montagem do SVC numa válvula	76	Indicador de Duração de Vida da Pilha.....	83
Montagem sobre um lado da caixa de inspecção	76	Guia de Resolução de Problemas	84
Montagem numa estaca	77		
Ligação de um Sensor de Chuva.....	77		
Programação.....	78		
Regulação da data e da hora	78		
Regulação dos Tempos de Início de Rega	78		
Cancelamento de uma hora de início de rega	79		
Regulação do Tempo de Funcionamento (Duração da Rega)	79		
Regulação dos dias de rega	79		
Seleção de dias da semana específicos com rega	80		
Seleção de um intervalo entre duas regas	80		





CARACTERÍSTICAS DO SVC

- Programação com o simples apertar de um botão
- Controla até quatro válvulas
- Grande Visor de Cristal Líquido (LCD) com ícones de fácil compreensão
- Funciona com pilhas alcalinas standard de 9 volts
- Calendarização de regas por dias da semana
- Até nove horas de Início de rega por dia
- Tempos de Funcionamento de 1 minuto a 4 horas
- Rega Manual
- Indicador do tempo útil de vida das pilhas.
- Sensor de Chuva (ou outro sensor electrónico de corte) compatível
- Múltiplas opções de montagem
- Memória não volátil mantém toda a informação programada

COMPONENTES SVC

Esta secção proporciona uma visão geral de alguns dos componentes do SVC. Mais à frente, cada componente será analisado com maior detalhe, no entanto, esta secção ajudá-lo-á a conhecer as diferentes opções disponíveis.

Visor LCD

1. **Ecrã Principal** – Indica toda a informação programada.
2. **Número da Estação** – Indica o número da estação que está a ser programada.
3.  **Data e Hora Actuais** – O ícone indica a data e a hora actuais.
4.  **Tempo de Funcionamento** – O ícone indica o Tempo de Funcionamento. Permite ao utilizador programar períodos desde 1 minuto a 4 horas.
5.  **Hora de Início** – O ícone indica a Hora de início de rega.
6. **Número da Hora de Início de Rega** – Indica o número da Hora de inicio de rega, desde 1 até 9.
7.  **Dias de Rega** – Permite ao utilizador seleccionar dias concretos para regar ou o número de dias de intervalo entre regas.

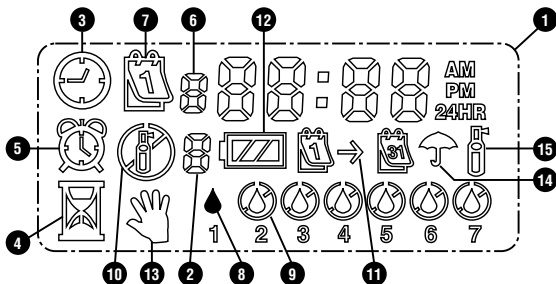

8. **▲ Gota de Chuva** – Indica que a rega se fará num dia seleccionado.
9. **☉ Gota de Chuva com uma Cruz** – Indica que a rega não se fará num dia seleccionado.
10. **☹ Aspersor com uma Cruz** – Indica que a rega está suspensa.
11. **📅 → 📅 Calendário** – Indica que o calendário dos intervalos de rega está a ser programado. Permite ao utilizador programar regas com intervalos de 1 a 31 dias.
12. **🔋 Situação das Pilhas** – Indica a vida útil das pilhas do SVC.
13. **🖐 Rega Manual** – O ícone indica que está programada a rega manual. Permite ao utilizador activar as estações

manualmente.

14. **☂ Guarda-Chuva** – O ícone indica que o sensor de chuva desligou o sistema.
15. **🚿 Aspersor a piscar** – O ícone indica que a rega está a decorrer.

Botões de Controlo

- ➔ **Botão** – Aumenta o que estiver seleccionado (a piscar).
- ➜ **Botão** – Diminui o que estiver seleccionado (a piscar).
- 👁 **Botão** – Selecciona a função de programação.
- ▶ **Botão** – Avança para a função a seguir àquela em que nos encontramos.
- ◀ **Botão** – Retrocede para a função anterior àquela em que nos encontramos.

INSTALAÇÃO DA PILHA

O SVC é alimentado por uma pilha alcalina de 9 volts (não fornecida) que é necessária para o programar e para accionar a válvula. A duração de vida da pilha é determinada pelo número de accionamentos da válvula, todavia, em condições normais de funcionamento, a pilha garante uma autonomia de pelo menos um ano de utilização.



NOTA: O SVC contém uma memória não volátil que lhe permite trocar a pilha sem perder as informações de programação.

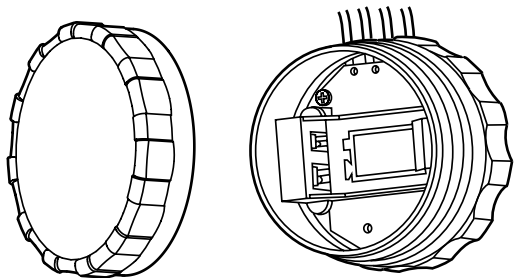

Instalação da pilha

1. Desparafuse a parte traseira da caixa do SVC para aceder ao compartimento da pilha.
2. Posicione a pilha no respectivo compartimento.



NOTA: O compartimento foi concebido de maneira a permitir a inserção da pilha apenas na posição correcta.

3. Certifique-se de que não há água no interior do compartimento da pilha. Aparafuse novamente a parte traseira da caixa para fechar o programador.

INSTALAÇÃO DOS SOLENÓIDES

O SVC-100 vem com um solenóide atado ao programador. Os programadores multistção SVC-200 e SVC-400 vão operar até 2 ou 4 solenóides. O SVC-400 é capaz de comandar até quatro solenóides de 9V. Os solenóides da Hunter (Ref. 458200) podem ser facilmente instalados em todas as Válvulas de Plástico da Hunter. Os solenóides para o SVC-200 e SVC-400 devem ser pedidos separadamente.



NOTA: Deve Usar os Solenóides de 9V. Solenóides 24VAC não funcionarão com o SVC.

Ligação Comum (Fios Pretos)

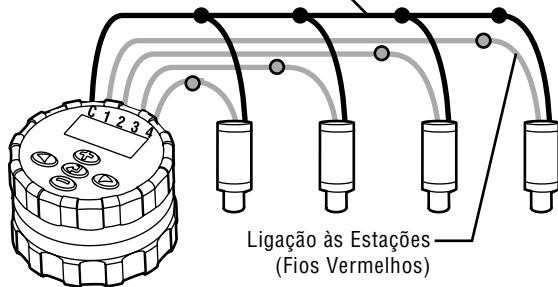

Ligação dos Solenóides 9V ao SVC:

1. Ligue os fios pretos de cada solenóide ao único fio comum que vem do SVC (fio preto). Fixe todas as ligações de fios eléctricos com conectores à prova de água.
2. Ligue um fio vermelho de cada solenóide ao fio da estação correspondente (fio vermelho) desde o SVC. O número da estação está indicado na parte da frente do SVC. Fixe todas as ligações de fios eléctricos com conectores à prova de água.



NOTA: O comprimento máximo do fio entre o solenóide e o SVC é de 30 metros (fio de secção mínima de 1,5 mm²).

O SVC também pode comandar solenóides de 9V que não sejam da Hunter. Indica-se abaixo uma lista de solenóides de 9V compatíveis com o SVC.

Modelo	Electromagnético
Baccara	G75-0-1002
Bermad	S392-2
Nelson	8090
Rain Bird	TBOSPSOL

MONTANDO O SVC

O SVC pode ser facilmente montado em qualquer válvula Hunter em plástico. Um anel de fixação especialmente concebido para este efeito permite uma montagem rápida do programador sobre a válvula. O SVC é fornecido com uma tampa em borracha, para impedir a acumulação de detritos na parte frontal do SVC.

Montagem do SVC numa válvula (Figura 1)

1. Desaperte o solenóide existente e retire-o da válvula.
2. Aparafuse o solenóide de 9V (Hunter 458200) na válvula.
3. Aperte o lado maior do anel de fixação na parte central da caixa do SVC.
4. Aperte o lado menor do anel de fixação no solenóide.



Figura 1

Um anel de fixação universal e um adaptador de montagem são igualmente fornecidos com o SVC. Estas peças permitem fixar o programador ao lado da caixa de inspeção, ou montá-lo numa estaca no interior da caixa de inspeção da instalação de rega.

Montagem sobre um lado da caixa de inspeção (Figura 2)

1. Posicione o adaptador de montagem universal sobre o lado da caixa de inspeção. Antes de escolher a posição certifique-se de que o programador depois de montado não impede o fecho da tampa da caixa de inspeção da rega.
2. Utilize dois parafusos para fixar o adaptador sobre o lado da caixa de inspeção.
3. Fixe o anel de manutenção no SVC e faça-o deslizar na extremidade do adaptador de montagem.

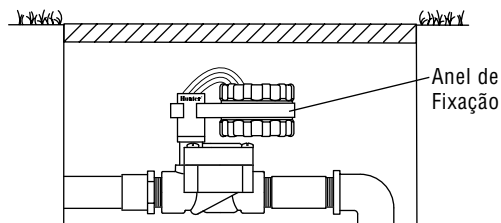

Figura 2

Montagem numa estaca (Figura 3)

O adaptador de montagem universal pode igualmente ser utilizado para montar o SVC numa estaca.

1. Corte um pedaço de tubo em matéria plástica com um diâmetro de 13mm ou ½".
2. Afunde o tubo no chão no interior da caixa de inspecção da instalação de rega, até à altura de montagem do programador.
3. Faça deslizar o adaptador de montagem sobre o tubo.
4. Prenda o grampo de bloqueio no SVC e introduza-o no adaptador de montagem.

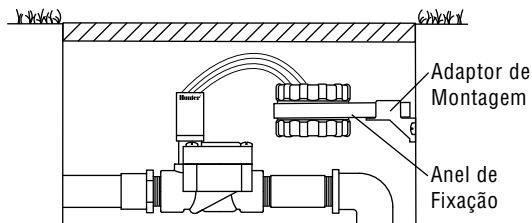

Figura 3

LIGAÇÃO DE UM SENSOR DE CHUVA

Um pluviómetro Mini-Clik® da Hunter, ou qualquer outro tipo de pluviómetro por micro-contacto, pode ser ligado ao SVC. A função do pluviómetro é interromper a rega quando as condições meteorológicas o aconselharem.

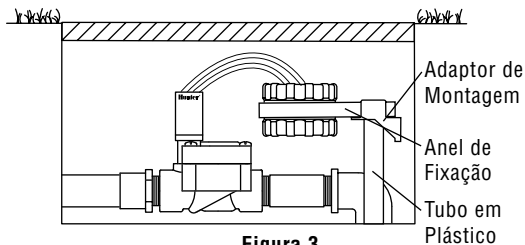

NOTA: Quando o pluviómetro interrompe a rega, o ícone ☹️ indicando a desactivação do sistema, (OFF) e o ícone ☂️ aparecem no display.



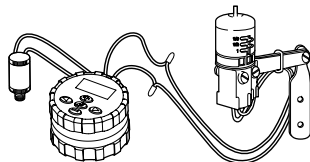



1. Corte ao meio o fio amarelo em forma de laço fixado no SVC.
2. Descarne cerca de 13mm de cada uma das duas extremidades do fio. Ligue cada uma dessas extremidades a um dos dois fios do pluviómetro. Pode montar o sensor de chuva até uma distância máxima de 30 metros do controlador SVC (fio de secção mínima de 1,5mm²).
3. Proteja as ligações utilizando conectores à prova de água.



Modelo Hunter Mini-Clik®



PROGRAMAÇÃO

O SVC utiliza uma programação independente por cada estação. Para cada estação que estiver a programar, precisa de programar pelo menos uma Hora de Início, um Tempo de Funcionamento e Dia(s) de Rega. O botão  permite-lhe navegar rapidamente entre as opções de programação.











O visor do SVC indica a hora e a data do dia quando você pressiona o botão . Este botão  permite-lhe também navegar de uma opção de programação para outra. Passado algum tempo de inactividade, o visor apaga-se de modo a economizar a pilha. Durante a programação, pode alterar as indicações que aparecem intermitentes pressionando os botões  ou . Para alterar uma indicação que não esteja intermitente, aperte os botões  ou  até que a função desejada comece a piscar.

O SVC permite programar até 9 horas de início de rega por dia. Estes tempos de início múltiplos permitem-lhe regar de manhã, à tarde e à noite, o que é perfeito para a formação de novos relvados e para a rega de flores anuais que exijam muita água. Indique simplesmente os dias da semana em que pretende regar, o SVC faz o resto.

Regulação da data e da hora



1. Prima o botão  até aparecer o ícone  representando

a data/hora actual.











2. A indicação da hora estará intermitente. Aperte o botão  ou  para mudar a hora indicada no visor. Aperte o botão  para passar à regulação dos minutos.
3. A indicação dos minutos está intermitente. Aperte o botão  ou  para mudar os minutos indicados no visor. Aperte o botão  para passar à selecção de AM, PM ou à visualização em 24 horas.
4. A hora é visualizada estando intermitente. Aperte o botão  ou  para seleccionar AM, PM ou 24 horas. Aperte o botão  para passar à regulação do dia da semana.
5. O dígito 1 que indica o primeiro dia da semana estará intermitente. Aperte o botão  ou  para seleccionar o dígito (1 a 7) correspondente ao dia da semana.

A data e a hora estão agora reguladas.



Regulação dos Tempos de Início de Rega

1. Pressione o botão  até aparecer o ícone  representando a Hora de início de Rega. Um Arranque de Ciclo ou a palavra "Desligado" estará piscando. O número imediatamente à esquerda da hora do arranque do ciclo (de 1 a 9) indica o número do arranque de ciclo. O número imediatamente abaixo do número do arranque

do ciclo indica a estação que está sendo programada.

- Utilize o botão  ou  para mudar a Hora de início; (o tempo de início muda por incrementos de 5 minutos). Mantenha a pressão num desses botões para mudar rapidamente a hora.
- Para acrescentar outra hora de início de rega à estação, carregue no botão . O ícone da hora de início e o seu número estarão a piscar. Utilize os botões  ou  para modificar o número da hora de início.
- Carregue no botão . A hora de início estará a piscar. Use os botões  ou  para mudar a hora de início.
- Para programar horas de início para outra estação, carregue no botão . Estará a piscar o número da estação. Use os botões  ou  para seleccionar a próxima estação (de 1 a 4). Repita os passos 3 e 4.





Cancelamento de uma hora de início de rega

Quando o visor estiver no modo hora de início de rega, prima o botão  ou  até visualizar 12:00 AM (meia-noite). Aperte então uma vez o botão  para visualizar OFF.









NOTA: Se os 9 tempos de início de rega forem todos desactivados (OFF), então a própria estação estará desactivada.

Regulação do Tempo de Funcionamento (Duração da Rega)





- Aperte o botão  até aparecer o ícone  representando o tempo de funcionamento.
- O visor indica o último tempo de funcionamento programado.
- Utilize o botão  ou  para mudar o tempo de funcionamento da estação no visor e ajustá-lo entre 1 minuto e 4 horas.
- Aperte o botão  para navegar para o próximo número de estação a programar.

Regulação dos dias de rega

- Aperte o botão  até aparecer o ícone  representando os dias de rega. O número da estação também vai ser mostrado.
- O programador apresenta os sete dias da semana com o ícone  ou o ícone  em cima de cada dia. O ícone  indica os dias em que há rega, enquanto o ícone  indica os dias em que não há rega.
- Aperte o botão  para navegar para o próximo número de estação a programar.







PROGRAMAÇÃO (Continuado)

Seleção de dias da semana específicos com rega

1. Com o cursor  colocado sobre um dia específico (o cursor começa sempre pelo 1), aperte o botão  para programar o dia da semana em que há rega. Aperte o botão  para anular a rega nesse dia. Depois de ter apertado um botão, o cursor passa automaticamente ao dia seguinte.
2. Repita a etapa 1 para todos os dias da semana que pretende programar com rega. Os dias seleccionados aparecem com o ícone  que indica que esses dias são dias COM rega. O último ícone  indica o último dia de rega do programa.

→ Seleção de um intervalo entre duas regas

Esta opção permite-lhe seleccionar um intervalo entre duas regas compreendido entre 1 e 31 dias.

1. Com o cursor  sobre o dia 7, aperte o botão  até aparecer no visor o ícone de intervalo de rega  →  e os dois calendários.
2. Aperte o botão  ou  para seleccionar o número de dias (1 a 31) entre dois ciclos de rega. Este número será o intervalo de rega.

Neste caso, o programador iniciará a rega na próxima hora de início regando consoante o intervalo de rega definido pelo utilizador.



Programação de Estações para que Funcionem em Conjunto (SVC-200 o SVC-400)

O SVC-200 o SVC-400 permitem a rega automática com múltiplas válvulas em simultâneo. Podem funcionar simultaneamente até quatro estações. Se houver mais de uma estação com o mesmo tempo de início, elas funcionarão em simultâneo (também devem ser programadas com o mesmo dia de rega). Por exemplo, se a Estação 1 e a 2 tiverem sido ambas programadas com tempos de início para as 8:00 AM, ligar-se-ão ambas ao mesmo tempo e funcionarão em simultâneo.



O SVC permite tempos de início escalonados, o que é útil quando a capacidade do sistema não é adequada para suportar o funcionamento de múltiplas válvulas ao mesmo tempo. Imaginemos uma situação em que a Estação 1 está programada para começar às 8:00 AM e funcionar durante 15 minutos e a Estação 2 está programada para começar às 8:10 AM e funcionar durante 15 minutos. O tempo de funcionamento de rega da Estação 1 sobrepõe-se ao tempo de início da Estação 2. O SVC esperará até que a Estação 1 complete a rega antes de iniciar a Estação 2. Neste cenário, a Estação 2 arrancará às 8:15 AM.

Desactivação do sistema

Esta função permite-lhe parar o sistema por um período indefinido.



1. Aperte o botão  até aparecer o ícone  representando um aspersor com uma cruz.
2. Aguarde 4 segundos até aparecer “OFF” no visor. O SVC está agora em modo de sistema desactivado e permanecerá assim até que você o active novamente.

Reactivação do sistema após a desactivação



1. Aperte uma vez o botão . O visor acende-se em modo Sistema desactivado.
2. Aperte novamente o botão  para fazer desaparecer a indicação “OFF”. O visor vai mostrar a hora actual. O programador está agora activado e controlará automaticamente a rega segundo o programa de rega actual.

Interrupção de rega programável

Esta função permite-lhe interromper todos os programas de rega durante um determinado período de tempo, compreendido entre 1 e 7 dias. Terminado o período de interrupção de rega programado, o programador retorna ao modo de funcionamento normal.

1. Aperte o botão até  aparecer o ícone  indicando





que o sistema está desactivado. Espere 4 segundos e a palavra “off” (desligado) vai aparecer no visor.

2. Aperte o botão , o dígito 1 aparece. O 1 fica intermitente nesta fase.
3. Aperte o botão  tantas vezes quantas for necessário para programar o número de dias pretendido (até 7). O SVC vai esperar o número de dias seleccionado, e então vai reativar a rega automática.



Rega em modo manual

O SVC vem com um arranque manual simples de um toque. Uma ou mais estações podem ser programadas para funcionar manualmente ao mesmo tempo.

Para activar a rega manual



1. Aperte uma vez o botão  para fazer aparecer o ícone representando a data / hora actual.
2. Aperte o botão  e mantenha-o pressionado durante dois segundos para fazer aparecer o ícone  representando a rega em modo manual. O número da estação também vai ser mostrado.
3. Utilize o botão  ou  para ajustar a duração da rega manual entre 1 minuto e 4 horas.
4. Liberte os botões e o programador activará o ciclo de rega manual passados 10 segundos.

PROGRAMAÇÃO (Continuado)



5. O ícone  representando um aspersor intermitente aparece no visor indicando que a rega está em curso.
6. Para activar outra estação, use o botão  para seleccionar a estação onde deseja fazer a rega manual, repita os passos 3 e 4.

Nota: Enquanto estiver a fazer a rega manual, o visor mostrará por instantes o número da estação e o tempo de rega restante para cada estação que esteja a funcionar. O tempo de rega manual pode ser aumentado ou diminuído em qualquer altura que se mostre o número da estação.



Para Suspender a Rega Manual em Todas as Estações em Funcionamento

1. Aperte o botão  até que apareça o ícone de Desligar  o Sistema (System Off). Espere 4 segundos e aparecerá "OFF" no visor. Desligar-se-ão todas as estações.
2. Aperte outra vez o botão  e mostrar-se-ão a data e o tempo actuais. O SVC passará agora a regar segundo o que estiver programado.

Para Suspender a Rega Manual em Estações Concretas em Funcionamento

1. Aperte o botão  e o visor mostrará cada uma das estações que esteja a funcionar manualmente.
2. Quando apareça o número da estação onde quer suspender a rega manual, aperte o botão  uma vez. O tempo restante que se mostra passará a "Off" e desligar-se-á a estação.
3. Repita os passos 1 e 2 para suspender a rega noutras estações.

INDICADOR DE DURAÇÃO DE VIDA DA PILHA

O ícone  representando a pilha é um meio rápido de verificação do estado actual da pilha sem precisar de a retirar do programador. O ícone de representação do estado da pilha aparece ao lado da indicação da data e da hora. Quando a pilha está completamente carregada, os três segmentos do ícone aparecem em preto . À medida que a pilha se descarrega, os segmentos aparecem em cor clara .

GUIA DE RESOLUÇÃO DE PROBLEMAS

PROBLEMA	CAUSAS	SOLUÇÕES
Não aparece nada no display.	O display está desactivado. A pilha está descarregada.	Prima qualquer botão durante 1 segundo. Substituir a pilha.
O display indica que a rega está em curso, mas nenhuma rega se produz.	A água está sem pressão. O solenóide está defeituoso. Solenóide incompatível.	Abra o circuito de distribuição de água. Substitua o solenóide. Deve-se usar Solenóide de Engatamento DC Hunter (P/N 458200) ou outro solenóide de engatamento DC compatível.
A rega automática não começa na hora de arranque programada.	O programador está em modo sistema desactivado. A hora actual não foi correctamente regulada. A hora de arranque de ciclo não foi correctamente regulada.	Verifique se o programador está activo. Ajuste correctamente a hora actual. Ajuste correctamente a hora de arranque de ciclo.
O pluviómetro não interrompe a rega.	O pluviómetro está defeituoso ou foi mal instalado.	Verifique se o pluviómetro funciona correctamente e se foi bem instalado.
O programador inicia a rega mais de uma vez.	Um número excessivo de arranques de ciclo foi programado (até 9 arranques de ciclo por dias).	A hora de arranque de ciclo activa um ciclo completo de rega (ver “Regulação dos arranques de ciclo de rega”). Programe apenas um arranque de ciclo por vez por dia de rega.

Hunter Industries Incorporated • The Irrigation Innovators

© 2006 Hunter Industries Incorporated

U.S.A.: 1940 Diamond Street • San Marcos, California 92078 • www.HunterIndustries.com

Europe: Bât. A2 - Europarc de Pichaury • 1330, rue Guillaibert de la Lauzières • 13856 Aix-en-Provence Cedex 3, France • TEL: +33 (0) 442-37-16-90 • FAX: +33 (0) 442-39-89-71

Australia: 8 The Parade West • Kent Town, South Australia 5067 • TEL: (61) 8-8363-3599 • FAX: (61) 8-8363-3687

P/N 715064

LIT-382

2/06